

ABRIL: OPORTUNIDADES DE ALTA ROTACIÓN

Impulsa **tus ventas** de temporada con el inventario de mayor rotación en el mercado.



PSA-220

Amplificador de Potencia
Profesional de 120W



PSP-72C

Cabina Activa 8" con Batería
Recargable y Bluetooth



JV-T20

Teclado gamer
Alámbrico



También disponible:

- Accesorios para celulares.
- Cargadores para portátiles.
- Adaptadores y convertidores.
- Cables y extensiones.
- Miscelánea tecnológica.
- Controles para televisores.
- y mucho más.

Precios más IVA

Habla con tu asesor y haz tu pedido



VENTAJAS DE TRABAJAR CON **NOSOTROS.**

En **YANPO** nos dedicamos a la **importación de productos tecnológicos y de conectividad**; para ventas al por mayor.



Contamos con nuestra marca registrada **YANPO** y **mas de 1.500 referencias** para que tu empresa crezca con nosotros.

Te ofrecemos **productos de excelente calidad**, contamos con cables de diferentes clases, HDMI, poder, para impresora, convertidores de señal de audio y video, cargadores para portátil, dispositivos bluetooth, entre otros productos.



Manifiestos de importación.



Factura electrónica.



Agilidad de envíos.



Somos importadores.



Calidad garantizada.



Sin intermediarios.

YANPO[®]
ELECTRONIC TECHNOLOGY



CONOCE NUESTRO MÉTODO DE TRABAJO



Para registrarte en nuestro sistema, necesitaremos tu RUT actualizado o cédula de ciudadanía.



Si deseas realizar un pedido, debes enviar un listado detallando los códigos de los productos y cantidades que requieres en formato excel, word, PDF o imagen, a través de tu asesor comercial o los siguientes canales: yanpoventas@gmail.com y líneas de whatsapp: 312 638 8056 - 319 372 9770.



Seguido a esto, ingresaremos tu pedido a nuestro sistema. Una vez confirmadas las existencias en bodega, te enviaremos la proforma con los productos disponibles detallando el precio total de tu pedido.



Aceptado el pedido debes realizar el pago por cualquiera de nuestros canales de Pago Autorizados.



Envías el soporte de pago via whatsapp o correo electrónico para obtener el consecutivo de seguimiento de tu envío.



Recuerda que para realizar tu pedido, este debe ser por un valor mínimo de \$300.000 IVA Incluido.

ÍNDICE

A

Adaptador Bluetooth	220, 221
Adaptador Viajero	227
Adaptador De Voltaje	197.....210
Adaptadores HDMI y USB	122, 123
Amarras	268
Antenas	81, 82
Antena WIFI	225
Arduinos	288.....324
Aspiradora manual	89
Audifonos Bluetooth	262
Audiófonos Manos Libres	253, 254

B

Bascula De Bolsillo	271
Base Monitor y Televisor	90, 91
Base Y Soporte Para Portatil	247, 248
Bases Para Cautin	56
Bisturi	69
Bolsa Para Envios	273
Bombas Para Fuente	269, 270

C

Cabinas de sonido	8, 9, 10
Cable De Poder Sata	124
Cable Displayport	138
Cable HDMI 4K	136
Cable HDMI	133, 134, 135
Cable HDMI 8K	137
Cable HDMI Fibra Optica	139
Cable HDMI Mini	140
Cable Optico	166, 167
Cable USB Activa	164, 165
Cable UTP Categoria 5	157
Cable UTP Categoria 6	156
Cable UTP Categoria 7	155
Cable VGA	131, 132
Cables De Audio 1x1	143
Cables De Audio 2x1	145
Cables De Audio 2x2	146
Cables De Audio 3x3	146, 147
Cables De Impresoras	169, 170
Cables De Poder	171,172,173
Cables Jumper	285
Cables Para Audio	149.....154
Cables Para Celular	257.....261
Cables Para Varios Usos	174.....179
Cables Telefonicos	141, 142

Cables USB Macho-Macho	159,160
Caja Para Disco Duro	239
Cajas Para Rj45	159
Capturadora HDMI	222
Capuchones Y Conector Rj45	126, 127
Cargador De Baterias	66
Cargador De Celular Para Carro	263
Cargadores Apple	182
Cargadores Lenovo	190
Cargadores Monitor LG	191
Cargadores Para Acer	184
Cargadores Para Asus	185, 186
Cargadores Para Dell	187
Cargadores Para HP	188, 189
Cargadores Samsung	192
Cargadores Sony	194
Cargadores Tipo C	183
Cargadores Toshiba	193
Cautines	55
Cepillos Removedores	58, 59
Cinta Adhesiva	69
Cinta Conductiva	57
Cinta De Neon Flex	98
Cinta Led 5050 5 Metros	96
Cinta Led 5050 Magic	94
Cinta Led Cob	99
Cinta Metrica	69
Control Cintas Leds	95
Convertidor A Rj45	222, 223
Convertidores HDMI, RCA y VGA	215
Convertidores OTG Tipo C	212
Convertidores Tipo C	221
Corta Frio	61
Corta Frio, Pinza, Alicata	78
Crema Disipadora	129

D

Desoldador	77
Destornilladores	67, 68
Diademas Computador	251
Drivers Y Diafragma	30.....35

E

Estacion De Aire Caliente	54
Estacion De Carga	52
Estacion De Soldadura	53
Extender HDMI	218
Extension USB Activa	164, 165

F

Fuente De Poder DC	52
Fuentes De Poder	200
Funda, Protector Y Guaya Computador	249

H

Hub 7 y 10 Puertos	92
Hub Tipo C	93
Hubs 4 Puertos	92

I

Imanes Neodimio	286, 285
Impresos y Baquela	281
Integrados, Transistores	328
Inversor De Voltaje	66

L

Leds Con Disipador	326
Leds De 10,20,30,50 y 100W	327
Limpiadores	60, 61
Linterna Para Colgar	85
Linternas	86

M

Maquina De Afeitar	87
Maquina Para Cortar Cabello	87,88,89
Maquina Removedora De Pegamento	59
Maquina Removedora De Pelusa	89
Maquinas De Humo	230,231
Memoria SD, USB	241
Microfonos de PC y celulares	242,243
Microscopio digital	53
Microservo Y Sermotor	279
Mini Motor Tool	58
Modulo USB	216
Motor Y Llantas Proyectos Estudiantiles	276
Motoreductores	275
Mouse	232,233
Mouse Gamer	234,235
Multímetros	64

O

Organizadores	63
---------------	----

P

Paletas Para Desarmar Celulares	61
Panel Solar	83
Parlante Portable 5W de Mesa	117
Parlantes Bluetooth De 10W	112, 113
Parlantes Bluetooth De 20W	108.....111
Parlantes Bluetooth De 40W	105, 106, 107
Parlantes Bluetooth De 5W	114, 115
Parlantes Para Computador	118, 119, 120

Patillera	88
Pilas A10, A312	101
Pilas CR2016-CR2025	103
Pilas LR44-LR41-LR1130	102
Pilas Recargables AA-AAA	101
Pilas SR626-SR621	102
Pinzas	60
Pistola De Aire Caliente	61
Pistola Y Barra De Silicona	80
Ponchadoras	76,77
Portafusibles	282
Power Bank	261
Protoboard	284
Puntas Para Cautin	56
Puntas Para Computador	195,196
Puntas Para Multímetro	277

R

Regletas Macho y Hembra	282
-------------------------	-----

S

Selladora De Mano	272
Set Destornilladores	70.....75
Sirena	79
Soporte Con Doble Brazo	91
Soporte De Techo Video Beam	90
Soporte Fijo Para Tv	90
Soporte Para Decodificador	90
Soporte Para Disco Duro	241
Soporte Reclinable Para Tv	91
Soportes Para Celular	255, 256
Splitter HDMI	217
Suiches de Impresoras	216,217
Suiches De Red	245
Switch VGA Y HDMI	214,215

T

Tapete De Trabajo	62
Tarjeta De Sonido	213
Teclado	235,236,237
Tercera Mano Y Base Lupa	61
Terminales Coaxial	123
Tripodes	246
Tv Box, Tv Stick	238

V

Ventilador Solar	84,85
Video Balum	228

W

Walkie Talkie	246
---------------	-----



NUEVO PRODUCTO



40 W

INCLUYE:



79 CM

24 CM



VISTA SUPERIOR



VISTA POSTERIOR

Parlante Bluetooth 8"x2

Micrófono inalámbrico y control 40W /Luz led / TF card / Aux / USB / Tipo C / FM / Mic in / TWS



Función TWS



4500 mAh



Luces LED ritmicas



Bluetooth 5.0



Interfaz: BT, FM, SD Y USB

Cod. JV-JMA-8800

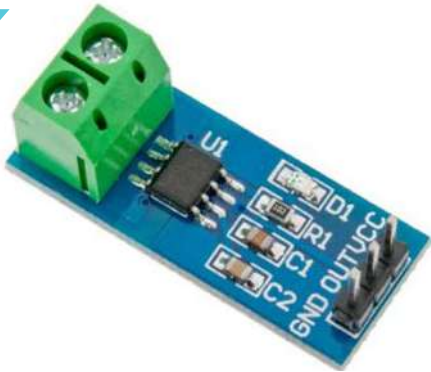

SENSOR CORRIENTE ACS712 ARDUINO

Cod. ARD-SC5A

Cod. ARD-SC20A.....

Cod. ARD-SC30A.....



PISTOLA DE AIRE CALIENTE

- Rango de temperatura de 300-600°C,
- Potencia: 1800W
- Flujo de aire: 300-500 L/Min, 110V

Cod. 855C

NUEVO PRODUCTO



CONVERTIDOR HDTV A HDTV + VGA+ SONIDO

Cod. JV-HDTV-600

NUEVO PRODUCTO



HUB 4 PUERTOS TIPO C 3.0 V

Cod. JV-TC303

NUEVO PRODUCTO



HUB USB C 3.0 - 4 PUERTOS MULTIPUERTO TIPO C - ALUMINIO

Cod. JV-HUBC4

NUEVO PRODUCTO



DIADEMA COMPUTADOR GAMING

sonido de alta fidelidad

Cod. JV-G108

NUEVO PRODUCTO



MOUSE GAMER ALAMABRICO 3D 1.200 DPI

JV-C8

NUEVO PRODUCTO



MOUSE GAMER ALÁMBRICO 7D

Cod. JV-Q1

RECIÉN LLEGADOS



SONIDO PROFESIONAL

PSP-51C

60W



PSP-72C

120W



**PRECIO
IMBATIBLE**



CABINA ACTIVA 8" CON BATERÍA RECARGABLE Y BLUETOOTH

Cabina de sonido activa de 8 pulgadas, ideal para uso portátil y comercial. Incorpora batería recargable de alta capacidad, conectividad Bluetooth con función TWS, y controles de ecualización para una experiencia de sonido potente y versátil.

Cod. PSP-72C



IDONEO PARA MÚSICOS

ESPECIFICACIONES TÉCNICAS:



AUDIO:

- Tipo: Altavoz activo portátil todo en uno.
- Potencia: **120W RMS**.
- Respuesta de frecuencia : **45 Hz – 18 kHz**.
- Máx. SPL (1 m, espacio libre): **114 dB**.
- Impedancia: **4 Ohm**.
- Woofer: **8" (1 unidad)**



CONTROLES:

- Número de canales del **mezclador**: **4**
- Preamplificadores de **micrófono**: **3**
- Ecuilización: **Ecuilizador de 3 bandas** por canal.
- Efectos integrados: **Delay**



CONECTIVIDAD:

- Bluetooth: **Sí, con función TWS**.
- Entradas:
 - 3 × XLR Combo (línea / guitarra / micrófono conmutables)
 - 1 × RCA
 - 1 × AUX
- Salida:
 - 1 × XLR de salida de línea



BATERIA:

- Tipo: Batería de litio.
- Capacidad: 4400 mAh.



Panel

120W RMS



3 Posiciones

CABINA ACTIVA 6.5" CON BATERÍA RECARGABLE Y BLUETOOTH

Cabina activa compacta de 6.5 pulgadas, equipada con tweeter tipo domo para una reproducción clara y balanceada.

Integra amplificador digital, múltiples opciones de entrada y batería recargable, ideal para aplicaciones portátiles, comerciales y profesionales.

Cod. PSP-51C

60W
RMS



TWS



ESPECIFICACIONES TÉCNICAS:

AUDIO:

- Tipo: Altavoz activo portátil todo en uno.
- Potencia: **60W RMS**.
- Respuesta de frecuencia (-6 dB): **60 Hz – 18 kHz**.
- Máx. SPL (1 m, espacio libre): **102 dB**.
- Impedancia: **4 Ohm**.
- Woofer: **6.5" coaxial**.
- Tweeter: **Cúpula de 0.8"**.

CONTROLES:

- Amplificación: **Clase D (digital)**.
- Mezclador integrado:
 - **2 entradas Mic/Línea**
 - **1 salida de línea**
- Ecualización: **2 bandas por canal**.

BATERIA:

- Tipo: Batería de litio.
- Voltaje: **110–240V | 50/60Hz**.
- Capacidad: **1500 mAh**.

CONECTIVIDAD:

- Entradas: **XLR / USB**
- Bluetooth: **Sí, con función TWS**.
- Reproducción USB



Display



Panel

60W RMS



3 Posiciones



PARLANTES AMBIENTALES

Parlantes ambientales pasivos diseñados para instalaciones fijas en interiores o exteriores bajo techo. Su diseño compacto y su soporte metálico ajustable permiten una orientación precisa del sonido, ideal para tiendas, oficinas, pasillos, restaurantes y sistemas de voz.

5"
PULGADAS



40W



Modelo: Pro Sound PSP-A76-5
Potencia máxima: 40W
Impedancia: 8Ω / Línea 100V
Transformador de línea
Respuesta de frecuencia: 75Hz-20kHz
Dimensiones: 239 × 161 × 144 mm
Peso: 2 Kg
Instalación: montado en pared

Cod. PSP-A76-5

4"
PULGADAS



30W



Modelo: Pro Sound PSP-A76-5
Potencia máxima: 30W
Impedancia: 8Ω / Línea 100V
Transformador de línea
Respuesta de frecuencia: 90Hz-20kHz
Dimensiones: 202 × 136 × 123 mm
Peso: 1,5 Kg
Instalación: montado en pared

Cod. PSP-A76-4

AMPLIFICADOR DE POTENCIA PROFESIONAL DE 120W - MODELO MULTICANAL



120W



35 CM

Para **2 zonas**. - Entrada **2 MIC**.
MP3/USB/SB/BT/FM.

2 canales/zonas con ajuste de volumen.
Canal central con ajuste de Bass y Treble con CHIME.
Karaoke ECHO. Efecto PA.

Potencia 120W.

Modo salida 4-16 Ω, 0 dos zonas de 100V.
60Hz-16KHz +/- 2dB.

T.H.D 0,10%.

Sensibilidad -50dB/600Ω.

Voltaje de entrada 110V 60Hz

Cod. PSA-220

AMPLIFICADOR DIGITAL 50W REPRODUCTOR MP3



50W



26,5 CM

Potencia nominal: 50W RMS.

Entrada **2 MIC**.

Modos de salida: 4-16Ω (altavoces convencionales)
70V y 100V (sistemas de línea constante).

Respuesta en frecuencia: 60Hz - 16kHz (±2dB).

Distorsión (THD): ≤0.1%

Relación S/N: 66dB (micrófono) 102dB (línea).

Sensibilidad de entrada: Micrófono: -50dB/600Ω

Línea: -10dB/10kΩ.

Doble Voltaje: DC 12V / AC 110-240V

Cod. PSA-568

AMPLIFICADOR DIGITAL ESTÉREO



60W



Amplificador digital estéreo compacto con Bluetooth, reproductor MP3 y múltiples entradas, volumen y efectos de eco. Ideal para audio ambiental, tiendas y sistemas básicos de sonido.

Potencia estéreo: hasta 30W + 30W.
Bluetooth integrado.

USB / FM / AUX.

Tres (3) entrada de **micrófono**.

Control de graves y agudos.

Control remoto incluido.

Impedancia: 4Ω / 8Ω.

Respuesta de frecuencia: 40Hz – 20kHz

Relación señal/ruido: ≥74 dB.

Doble Voltaje: DC 12V / AC 110–240V



Cod. PSA-315

AMPLIFICADOR DE AUDIO MULTIFUNCIÓN



40W



Amplificador de potencia compacto y versátil, diseñado para uso doméstico y profesional ligero. Integra múltiples fuentes de audio (Bluetooth, USB, FM, AUX) con control independiente de tono, volumen y efectos de eco, ideal para karaoke, sonorización de espacios pequeños y reproducción musical.

Potencia de salida: 20W + 20W (4Ω).

Respuesta en frecuencia: 40Hz – 20kHz (±2dB).

Relación señal/ruido: ≥74dB

Distorsión (THD): ≤0.19%

Doble Voltaje: DC12V o AC 110V–240V

Impedancia de altavoz: 4Ω u 8Ω

Peso y diseño: Compacto, portátil, fácil de transportar



Cod. PSA-811

RECIÉN LLEGADOS

Promoción del mes

cable de poder 1.5 MT - JV-CATREBOL



Lleva

1-29 unds

\$2.300

+IVA

Lleva

30-49 unds

\$2.000

+IVA

Lleva

50+ unds

\$1.600

+IVA

MICRÓFONOS



INCLUYE:



MICRÓFONO INALÁMBRICO UHF

- Micrófono Inalámbrico UHF.
- Receptor en banda (640 - 700 Mhz) Multicanal 24CH HD Display.
- Alcance máximo en línea de visión de hasta 50 metros.
- Receptor y micrófono con pantalla LCD.
- Mandos alimentados por baterías AA.
- Incluye baterías de litio 18650 para receptor.
- Incluye estuche de transporte tipo maletín.

Cod. PSM-080M



INCLUYE:



SET MICRÓFONOS INALÁMBRICOS UHF

- 2 Micrófonos de mano
- 2x48 CH(Canales).
- Receptor en banda UHF (600 - 690 Mhz).
- Alcance máximo en línea de visión de hasta 100 metros.
- Micrófono con pantalla HD display y puertos de carga tipo C.
- Receptor de 6.3mm.
- Receptor con puerto de carga tipo C.
- Mandos alimentados por baterías.
- Incluye 3 baterías 18650 de litio.

Cod. PMC-040MM



SET DE MICRÓFONOS INALÁMBRICOS UHF

- Kit de 2 micrófonos de mano.
- 2x100 CH (Canales).
- Frecuencia variable con procesador digital (DSP).
- Circuito anti-interferencia.
- Receptor y micrófono con pantalla LCD.
- Delay Time: <3ms
- Alcance hasta 100m
- Incluye 2 baterías de litio 18650.
- Incluye estuche de transporte tipo maletín.

INCLUYE:



Cod. PSM-210MM



SET DE MICRÓFONOS INALÁMBRICOS UHF

- Kit de 2 micrófonos inalámbrico de mano.
- 2x100 CH (Canales).
- UHF frecuencia variable con procesador digital (DSP).
- Circuito anti-interferencia.
- Receptor y micrófono con pantalla LCD.
- Incluye 2 baterías de litio 18650.
- Incluye estuche de transporte tipo maletín.

INCLUYE:



Cod. PSM-260MM



MICRÓFONO INALÁMBRICO UHF

- Micrófono Inalámbrico.
- Receptor en banda UHF (700 - 750 Mhz) Multicanal 30CH HD Display.
- Sistema DPLL Multicanal (Más estable, menos interferencias.)
- Alcance máximo en línea de visión de hasta 60 metros.
- Receptor y micrófono con pantalla LCD.
- Mando alimentado por baterías AA.
- Incluye 2 batería AA para micrófono.
- Incluye estuche de transporte tipo maletín

INCLUYE:



Cod. PSM-561M



SET DE MICRÓFONOS INALÁMBRICOS

- Dos (2) Micrófonos Inalámbricos.
- Receptor en banda UHF (700 - 750 Mhz) Multicanal 30CH HD Display.
- Sistema DPLL Multicanal (Más estable, menos interferencias.)
- Alcance máximo en línea de visión de hasta 60 metros.
- Receptor y micrófono con pantalla LCD.
- Mando alimentado por baterías AA.
- Incluye 4 baterías AA para micrófonos.
- Incluye estuche de transporte tipo maletín

INCLUYE:



Cod. PSM-562MM

SET MICRÓFONOS PROFESIONALES UHF



INCLUYE:



- Kit de 2 micrófonos de mano.
- Receptor en banda UHF (600 - 690 Mhz) Multicanal 2x100CH HD Display.
- Pantalla receptor TFT Full color.
- DPLL Technology.
- Alcance máximo en línea de visión de hasta 80 metros.
- Micrófonos con puerto de carga tipo C.
- Funcion autoescaneo.
- Sincronización por infrarojo.
- Receptor y micrófono con pantalla LCD.
- Mandos alimentados por baterías 18650.
- Incluye estuche de transporte tipo maletín.

Cod. PSM-740MM

SET DE MICRÓFONOS PROFESIONALES UHF



INCLUYE:



- Kit de dos (2) micrófonos, 1 de mano y 1 bodypack con posibilidad de diadema o solapa.
- Receptor en banda UHF (600 - 690 Mhz) Multicanal 2x100CH HD Display.
- Pantalla receptor TFT Full color.
- DPLL Technology.
- Alcance máximo en línea de visión de hasta 80 metros.
- Micrófonos con puerto de carga tipo C.
- Funcion autoescaneo.
- Sincronización por infrarojo.
- Receptor y micrófono con pantalla LCD.
- Mandos alimentados por baterías 18650.
- Incluye estuche de transporte tipo maletín.

Cod. PSM-740ML

SET DE MICRÓFONOS PROFESIONAL UHF DSP



- Kit de 2 micrófonos de mano.
- Receptor en banda UHF (640 - 700 Mhz) Multicanal 100CH HD Display.
- Distorsión armónica total <0.1%.
- Tasa de muestreo: 48KHz.
- Rango dinámico >90dB.
- Sistema autoescaneo y sincronización por infrarojo.
- Alcance máximo en línea de visión de hasta 80 metros.
- Receptor y micrófono con pantalla LCD.
- Mandos alimentados por baterías 18650.
- Incluye dos baterías 18650.
- Incluye estuche extraduro de transporte tipo maletín.

INCLUYE:



Cod. PSM-780MM

SET DE MICRÓFONOS PROFESIONAL UHF DSP CON BODYPACK



- Kit de 2 micrófonos, 1 de mano y 1 bodypack con posibilidad de diadema o solapa.
- Receptor en banda UHF (640 - 700 Mhz) Multicanal 100CH HD Display.
- Distorsión armónica total <0.1%.
- Tasa de muestreo: 48KHz.
- Rango dinámico >90dB.
- Sistema autoescaneo y sincronización por infrarojo.
- Alcance máximo en línea de visión de hasta 80 metros.
- Receptor y micrófono con pantalla LCD.
- Mandos alimentados por baterías 18650.
- Incluye dos baterías 18650.
- Incluye estuche extraduro de transporte tipo maletín.

INCLUYE:



Cod. PSM-780ML



MICRÓFONO ALÁMBRICO

- Modo de Cambio de Función: Dinámico.
- Directividad: Uni-direccional.
- Respuesta de Frecuencia: 60~14KHz.
- Sensibilidad: $-75\pm 3\text{dB}$ ($0\text{dB}=1\text{V}/\text{pa}$ at 1 KHz).
- Impedancia de Salida: $600\Omega\pm 30\%$ (at 1KHz).

INCLUYE:
Cable Canon



Cod. YP-181



MICRÓFONO ALÁMBRICO

- Modo de Cambio de Función: Dinámico.
- Directividad: Uni-direccional.
- Respuesta de Frecuencia: 60~14KHz.
- Sensibilidad: $-75\pm 3\text{dB}$ ($0\text{dB}=1\text{V}/\text{pa}$ at 1 KHz).
- Impedancia de Salida: $600\Omega\pm 30\%$ (at 1KHz).

INCLUYE:
Cable Canon



Cod. YP-168



INCLUYE:



MICRÓFONO ALÁMBRICO CUERPO METALICO

- Modo de Cambio de Función: Dinámico.
- Directividad: Uni-direccional.
- Respuesta de Frecuencia: 50~14KHz.
- Sensibilidad: $-71\pm 3\text{dB}$ ($0\text{dB}=1\text{V}/\text{pa}$ at 1 KHz).
- Impedancia de Salida: $600\Omega\pm 30\%$ (at 1KHz).

Cod. YP-801

MIXERS



MIXER 3 CANALES

 **BLUETOOTH**



- Mixer de 3 canales, interfaz de audio analógica.
- Phantom Power 48V.
- Reproductores mp3
- Efectos para micrófono.
- Interfaz de grabación RCA.
- Entrada híbrida XLR y línea.
- Ecuación de canales independientes, (Hi, Low).
- Control de ganancia.
- 2 entradas mono, 1 estéreo en canales RCA.
- Main Outs: 2 líneas L, R.
- Monitoreo por audífonos, display.

Cod. PMX-40FP



-5%



MIXER 4 CANALES

 **BLUETOOTH**

- Mixer de 4 canales, interfaz de audio análoga.
- Phantom Power 48V.
- Función Bluetooth.
- Entrada híbrida XLR y línea.
- Control de ganancia deslizable.
- Hi pass filter 80Hz.
- Ecuación de canales independientes (Hi, Mid, Low).
- 2 Entradas mono, 1 estéreo en canales 3/4 RCA o línea.
- Main Out: 2 líneas L,R.
- Monitoreo por audifonos, display.

Cod. PMX-40USB



-5%



MIXER 4 CANALES

 **BLUETOOTH**

- Mixer de 4 canales, interfaz de audio análoga.
- Funcion Bluetooth.
- Phatom Power 48V.
- Interfaz USB.
- Control de Volumen para audifonos
- Entrada híbrida XLR y línea.
- Control de ganancia deslizable.
- Hi pass filter 80Hz.
- Ecuación de canales independientes (Hi, Mid, Low).
- 2 Entradas mono, 1 estéreo en canales 3/4 RCA o línea.
- Main Out: 2 líneas L,R.
- Monitoreo por audifonos, display.

Cod. PMX-40





MIXER 6 CANALES

 **BLUETOOTH**

- Mixer de 6 canales, interfaz de audio análoga.
- Phantom Power +48V.
- Sistema de paneo.
- Funcion bluetooth.
- Interfaz de grabación RCA.
- Control de Volumen para audífonos.
- Entrada híbrida XLR y línea.
- Ecuación de canales independientes (Hi, Mid, Low).
- Control de ganacia, paneo y efectos.
- Efectos: Reverbación (Dep) y Delay/ Echo (Dlay).
- 2 Entradas mono, 1 estéro en canales 5/6 RCA.
- Main Out: Estereo 2 XLR/CANON
- Monitoreo por audifonos, display.



Cod. PMX-40X



MIXER 6 CANALES

 **BLUETOOTH**

- Mixer de 6 canales, interfaz de audio análoga.
- Interfaz de grabación RCA.
- Efectos de micrófono.
- Entrada híbrida XLR y línea.
- Ecuación de canales independientes (Hi, Mid, Low).
- Control de ganacia y paneo.
- 2 Entradas mono, 1 estéro en canales 5/6 RCA.
- Main Out: Estereo 2 XLR/CANON
- Monitoreo por audifonos, display.



Cod. PMX-MG6



MIXER 7 CANALES

 **BLUETOOTH**

- Efectos de micrófono.
- Phantom Power 48V.
- Función de paneo.
- Ecuación (Hi, Mid, Low).
- Módulo USB.
- Función Bluetooth.
- Salida de grabación RCA.
- Monitoreo por audifonos con control de volumen.
- Función de Bluetooth.

Cod. PMX-70USB

-5%



MIXER 7 CANALES

 **BLUETOOTH**

- Mixer de 7 canales, interfaz de audio análoga.
- Phantom Power +48V canales 1-2.
- Función Bluetooth.
- Interfaz de grabación análoga.
- Interfaz USB.
- Sistema de paneo.
- Entrada híbrida XLR y línea.
- PAD 26 Db effect.
- Hi pass filter 80Hz.
- Ecuación de canales independientes (Hi, Mid, Low).
- 2 Entradas mono, 1 estéreo en canales 6/7 RCA o línea.
- Main Out: 2 líneas L,R.
- Monitoreo por audifonos, display.

Cod. PMX-70

BASES PARA SONIDO

 **prosound**

-10%

BASE PARA CABINA

- Base para cabina con terminal metalico.
- Base en aluminio.
- Junta metálica.
- Pin de seguridad.
- Gomas protectoras.
- Altura máxima 1.74 m (ultimo pin).
- Altura mínima 1.15 m (primer pin)
- Mariposas para asegurar altura.
- Carga Máxima 80 Kg.
- Viene por caja de 6 Pcs.

Cod. PSB-15Y YELLOW





-10%

BASE PARA CABINA

- Base para cabina con terminal metalico.
- Base en aluminio.
- Junta metálica.
- Pin de seguridad.
- Gomas protectoras.
- Altura máxima 1.74 m (ultimo pin).
- Altura mínima 1.15 m (primer pin)
- Mariposas para asegurar altura.
- Carga Máxima 80 Kg.
- Viene por caja de 6 Pcs.

Cod. PSB-15R RED



-10%

BASE PARA CABINA

- Base para cabina con terminal metalico.
- Altura ajustable de 100 cm a 185 cm.
- Junta metálica.
- Pin de seguridad.
- Gomas protectoras.
- Carga Máxima 80 Kg.
- Viene en caja por 6 Pcs.

Cod. PSB-15B



BASE PARA SUBWOOFER

- Base para subwoofer con terminal metálico.
- Material: metálico.
- Uniones en metal.
- Altura regulable.
- Atura mínima 89 cm.
- Altura máxima 135 cm.
- Barra de seguridad.
- Peso máximo 50 Kg.
- Viene en caja por 6 Pcs.

Cod. PSB-41S

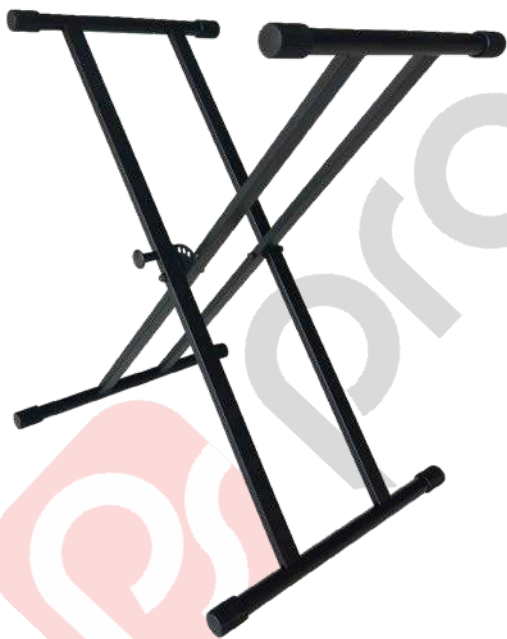

BASE PARA ORGANETA DOBLE SOPORTE

- Longitud superior 395 mm.
- Longitud inferior 485 mm.
- Longitud media 940 mm.
- Viene en caja por 4 Pcs.

Cod. PSB-73D





BASE PARA MICRÓFONO TIPO BOOM DOBLE SOPORTE

- Soporte completo: Base trípode/redonda + Brazo boom ajustable.
- Altura, longitud de boom y ángulo totalmente ajustables.
- Construcción metálica.
- Unión trípode en plástico.
- Altura máxima brazo expandible 1.90m.
- Altura máxima extensor vertical 1.38m.
- Incluye dos abrazaderas
- 4 posiciones ajustables.
- Plegable para transporte y almacenamiento (modelos trípode).
- Viene en caja por 12 Pcs.

Cod.PSB-78



SOPORTES PARA MICRÓFONO DE GRABACIÓN

- Material de construcción: Hierro
- Largo del brazo superior: 36 cm
- Largo del brazo inferior: 35 cm
- Color: Negro
- Base: Morsa para agarre en mesa
- Incluye pipeta

Cod. PSB-70M

**PRECIO
IMBATIBLE**

MEGÁFONO DE 9" 50W



- Megafono de 9"
- Potencia de 50W
- Función Bluetooth.
- Con micrófono.
- Sirena Incorporada.
- Grabación de 260 Segundos.
- USB/BT/SD/AUX.
- Incluye batería recargable de litio.

Cod. PMG-68BT



MEGÁFONO DE 5"- 30W

- Megafono de 5"
- Potencia de 30W
- Función Bluetooth.
- Con micrófono.
- Sirena Incorporada.
- Grabación de 260 Segundos.
- USB/BT/TF
- Incluye batería recargable de litio.

Cod. PMG-55BT





PARTE PARA MEGAFONO 68BT - MICROFONO CONTROL MEGAFONO DE 9" - 50W

Cod. REP68PO



REPUESTO DE BATERÍA PARA MEGAFÓNO PMG-68BT DE LITIO 7.4V 1500AH

Cod. REP68BA



UNIDAD PARA CORNETA DE PERIFONEO METÁLICA PARA ASEGURAR CON ROSCA DE 16 OHM.

Cod. YP-UC100

-5%



DRIVER DE TITANIO CON ROSCA

- Peso del iman: 13,3 OZ.
- Tamaño de la bobina de voz: 1,35".
- Respuesta de Frecuencia: 1K-20KHz.
- Sensibilidad (1W/1M): 100 dB.
- Impedancia: 8 Ohm.

Cod. PSD-344



-6%



DRIVER DE TITANIO CON ROSCA

- Peso del iman: 20 OZ.
- Tamaño de la bobina de voz: 1,75".
- Respuesta de Frecuencia: 1K-20KHz.
- Sensibilidad (1W/1M): 103 dB.
- Impedancia: 8 Ohm.

Cod. PSD-444

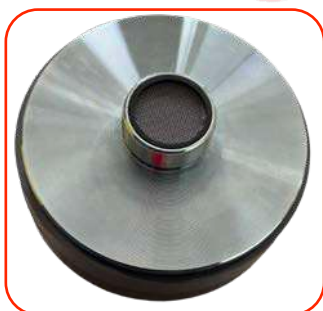



JUEGO DE TWEETER PIEZO ELÉCTRICO PARA CARRO CIRCULARES PLANOS.

Cod. YP-TW059



TWEETER PARA CARRO TIPO PIONEER



Cod. YP-TW339



DRIVER PLASTIC PIEZO ELECTRIC (75-150W) RMS (4/8 OHM) FOR TWEETER

Cod. YP-DPP01



**DRIVER DE TITANIO
1.1" (28MM)
30W - 8 OHM**

Cod. JV-CD-25



**DRIVER DE TITANIO
1.75" (44.4MM)
40W - 8 OHM**

Cod. JV-CD-44



**DRIVER DE TITANIO
1.35" (34.4MM)
30W - 8 OHM**

Cod. JV-CD-34

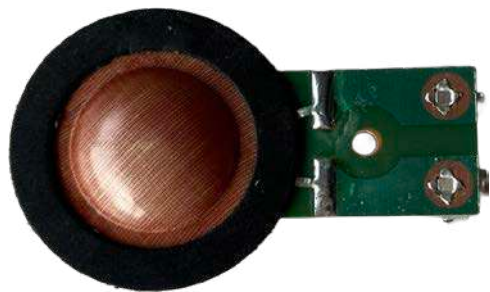

DIAFRAGMA PARA UNIDAD DE BRILLO 1", BAQUELITA LARGA

Cod. YP-DG21L



DIAFRAGMA PARA DRIVER 1.1" (28MM)

Cod. JV-TU25



DIAFRAGMA PARA DRIVER 1.35" (34.3MM)

Cod. JV-TU34



DIAFRAGMA PARA DRIVER 1.75" (44.4MM)

Cod. JV-TU44



DIAFRAGMA PARA DRIVER 2" (51MM)

Cod. JV-TU51

-10%



DIAFRAGMA PARA UNIDAD 1.75"

- Diafragma para drivers de diversas marcas que cumplan con las siguientes especificaciones:
- Diámetro de bobina 1.75" (44.45mm)
- Distancia entre terminales 3.5" (8.89mm)
- Altura entre la bobina y el domo 7/16"



Cod. PDG-444S

-10%



DIAFRAGMA PARA DRIVER CON TAPA 1.75"

- Diafragma para drivers de diversas marcas que cumplan con las siguientes especificaciones:
- Diámetro de bobina 1.75" (44.45mm)
- Distancia entre terminales 3.5" (8.89mm)
- Altura entre la bobina y el domo 7/16"
- Incluye tapa.



Cod. PDT-444TA

**NUEVO
PRECIO**

CABLE MICROFONO

CABLE ESTEREO 3 HILOS
CALIBRE 22AWG
(2 X 0,30MM2)

100 MTS

Cod. YP-CM22AWG



YANIPO®

Electronic Tech

CABLE RF COAXIAL RG58

DE BAJA PÉRDIDA.
FRECUENCIA MÁXIMA: 1000
MHZ. IMPEDANCIA: 50 OHMIOS
EMPAQUE: CARRETA X 305MTS.

Cod. YP-RG58





Cable DIGITAL 100% COBRE

Conector Canon Macho
x Canon Hembra 3 PINES



MEDIDAS	CÓDIGO
90 Cms	DGT-9127-90CM
1,8 Metros	DGT-9127-1-8M
3,6 Metros	DGT-9127-3-6M
5,5 Metros	DGT-9127-5-5M
7,5 Metros	DGT-9127-7-5M
10 Metros	DGT-9127-10M
15 Metros	DGT-9127-15M



Cable DIGITAL 100% COBRE

Conectores 2 Macho RCA
x 2 Macho RCA



MEDIDAS	CÓDIGO
90 Cms	DGT-9502-90CM
1,8 Metros	DGT-9502-1-8M
3,6 Metros	DGT-9502-3-6M
5,5 Metros	DGT-9502-5-5M
7,5 Metros	DGT-9502-7-5M
10 Metros	DGT-9502-10M
15 Metros	DGT-9502-15M



Cable DIGITAL 100% COBRE

Conector 1 Macho 3,5mm Stereo
x 2 RCA Macho



MEDIDAS	CÓDIGO
90 cms	DGT-9504-90CM
1,8 Metros	DGT-9504-1-8M
3,6 Metros	DGT-9504-3-6M
5,5 Metros	DGT-9504-5-5M
7,5 Metros	DGT-9504-7-5M
10 Metros	DGT-9504-10M
12 Metros	DGT-9504-12M
15 Metros	DGT-9504-15M



Cable DIGITAL 100% COBRE

Conector 1 Macho 3,5mm Stereo
x 1 Hembra 3,5mm Stereo



MEDIDAS	CÓDIGO
1,8 Metros	DGT-9504B-1-8M
3,6 Metros	DGT-9504B-3-6M
5,5 Metros	DGT-9504B-5-5M
7,5 Metros	DGT-9504B-7-5M
10 Metros	DGT-9504B-10M



Cable DIGITAL 100% COBRE

Conector 1 Macho 3,5mm Stereo
x 1 Macho 3,5mm Stereo



MEDIDAS	CÓDIGO
60 Cms	DGT-9504A-60CM
90 Cms	DGT-9504A-90CM
1,8 Metros	DGT-9504A-1-8M
3,6 Metros	DGT-9504A-3-6M
5,5 Metros	DGT-9504A-5-5M
7,5 Metros	DGT-9504A-7-5M
10 Metros	DGT-9504A-10M
15 Metros	DGT-9504A-15M



Cable DIGITAL 100% COBRE

Conector 2 Macho RCA
x 1 Macho 1/4 Monofonico

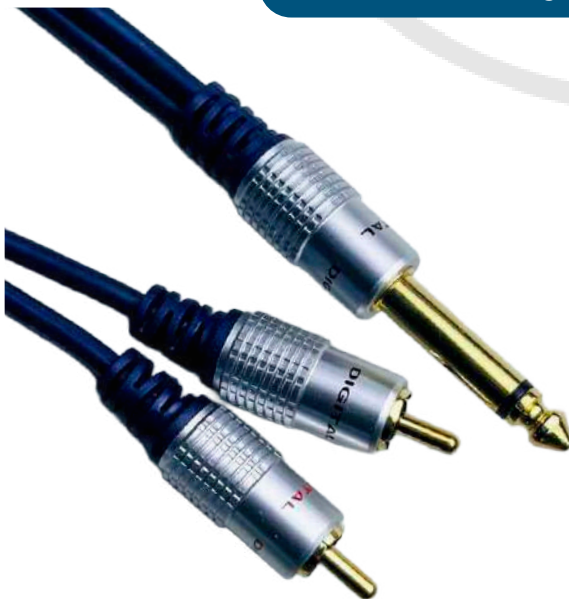

MEDIDAS	CÓDIGO
1,8 Metros	DGT-9506A-1-8M
3,6 Metros	DGT-9506A-3-6M



Cable DIGITAL 100% COBRE

Conector Plug de 1/4 Monofonico
x 1 Plug de 1/4 Monofonico



MEDIDAS	CÓDIGO
90 Cms	DGT-9527C-90CM
1,8 Metros	DGT-9527C-1-8M
3,6 Metros	DGT-9527C-3-6M
5,5 Metros	DGT-9527C-5-5M
7,5 Metros	DGT-9527C-7-5M



Cable DIGITAL 100% COBRE

Conector 2 Macho de 1/4 Monofonico
x 2 RCA Macho



MEDIDAS	CÓDIGO
90 Cms	DGT-9517-90CM
1,8 Metros	DGT-9517-1-8M
3,6 Metros	DGT-9517-3-6M



Cable DIGITAL 100% COBRE

Conector Macho 3.5mm Stereo
x Macho 1/4 Stereo



MEDIDAS

CÓDIGO

1,8 Metros DGT-9527F-1-8M

3,6 Metros DGT-9527F-3-6M

5,5 Metros DGT-9527F-5-5M



Cable DIGITAL 100% COBRE

Conector 1 Macho 3.5mm Stereo
x 1 Macho 1/4 Monofonico



MEDIDAS

CÓDIGO

1,8 Metros DGT-9527H-1-8M

3,6 Metros DGT-9527H-3-6M

5,5 Metros DGT-9527H-5-5M



Cable DIGITAL 100% COBRE

Conector 1 Macho 3,5mm Stereo
x 1 Macho Canon 3 PINES



MEDIDAS

CÓDIGO

1,8 Metros	DGT-9546-1-8M
3,6 Metros	DGT-9546-3-6M
5,5 Metros	DGT-9546-5-5M
7,5 Metros	DGT-9546-7-5M



Cable DIGITAL 100% COBRE

Conector 1 Macho 1/4 Stereo
x 1 Macho 1/4 Stereo



MEDIDAS

CÓDIGO

1,8 Metros	DGT-95271-1-8M
3,6 Metros	DGT-95271-3-6M



Cable DIGITAL 100% COBRE

Conector 1 Macho 1/4 Monofonico
x 1 Macho Canon 3 PINES



MEDIDAS

1,8 Metros

CÓDIGO

DGT-9544-1-8M



Cable DIGITAL 100% COBRE

Extensión 2 Plug Canon 3 PINES
x 1 Plug 1/4 Stereo



MEDIDAS

1,8 Metros

CÓDIGO

DGT-9546C-1-8M



Cable DIGITAL 100% COBRE

Conector Macho 3.5mm Stereo
x 2 Hembra 3.5mm Stereo



MEDIDAS

50 Cms

CÓDIGO

DGT-9566-50CM



Cable DIGITAL 100% COBRE

Extensión con Conector 1 Plug Canon
3 PINES x 2 Plug RCA



MEDIDAS

CÓDIGO

90 Cms DGT-9547-90CM

1,8 Metros DGT-9547-1-8M

3,6 Metros DGT-9547-3-6M



Cable DIGITAL 100% COBRE

Conector 2 Macho 1/4 monofonico
x 1 Macho 3.5mm



MEDIDAS

CÓDIGO

1,8 Metros DGT-9566A-1-8M

3,6 Metros DGT-9566A-3-6M

5,5 Metros DGT-9566A-5-5M



CABLES DE AUDIO 2X1 PREMIUM



MEDIDAS	CÓDIGO
2X1 RCA 1.8 MT	YP-2X1TR-1-8M
2X1 RCA 3 MT	YP-2X1TR-3M
2X1 RCA 4,5 MT	YP-2X1TR-4-5M
2X1 RCA 7,5 MT	YP-2X1TR-7-5M
2X1 RCA 10 MT	YP-2X1TR-10M
2X1 RCA 12 MT	YP-2X1TR-12M



CABLES DE AUDIO 2X2

PREMIUM



MEDIDAS	CÓDIGO
2X2 RCA 2 MT	YP-2X2TR-2M
2X2 RCA 3 MT	YP-2X2TR-3M
2X2 RCA 4,5 MT	YP-2X2TR-4-5M
2X2 RCA 8,5 MT	YP-2X2TR-8-5M
2X2 RCA 8,5 MT	YP-2X2TR-10M



CABLES DE AUDIO 3X3

PREMIUM



MEDIDAS	CÓDIGO
3X3 RCA 1,8 MT	YP-3X3TR-1-8M
3X3 RCA 3 MT	YP-3X3TR-3M
3X3 RCA 4,5 MT	YP-3X3TR-4-5M
3X3 RCA 7,5 MT	YP-3X3TR-7-5M



CABEZA DE MICROFONO METALICA

Cod. YP-REP3-5



PROTECTOR CORTAVIENTO PARA MICRÓFONO NEGRO PAQUETE X 5 UNDS.

Cod. YP-EPBL



PORTA MICRÓFONO GRANDE CON ROSCA METÁLICA.

Cod. YP-PMG100



PORTA MICRÓFONO TIPO PINZA

Cod. YP-PM120P



PLUG SPEAKON DE 4 CONTACTOS SIN PROTECTOR.

Cod. YP-PG107



**JACK CANON METÁLICO
SILVER.**

Cod. YP-PG170



**PLUG CANON METÁLICO
SILVER
POR UNIDAD (1)**

Cod. YP-PG175



**PLUG CANON CON
PROTECTOR PLÁSTICO
POR UNIDAD (1)**

Cod. YP-PG180



**JACK CANON CON
PROTECTOR PLÁSTICO.
POR UNIDAD (1)**

Cod. YP-PG185



**PLUG 3.5MM METÁLICO
ESTÉREO SILVER.
POR UNIDAD (1)**

Cod. YP-PG150



**JACK PARA CHASIS
MONOFÓNICO
METÁLICO**

Cod. YP-JKMONO



**JACK PARA CHASIS
STEREO METÁLICO**

Cod. YP-JKSTER

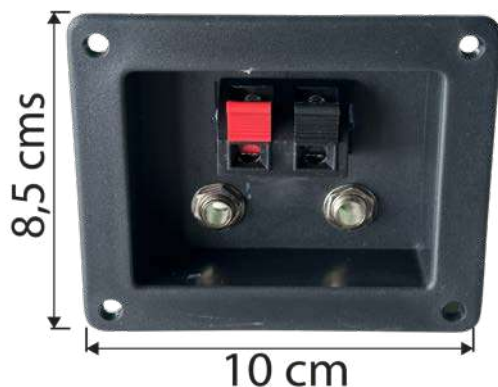

**TERMINAL DOBLE
SERVICIO PLUG Y
PRESIÓN.**

Cod. YP-TC2

16,5CM



23CM

**MANIJA METÁLICA GRANDE PARA
CABINAS.**

Cod. YP-MMG18



**ADAPTADOR METÁLICO
(SOMBRERO) DE 10.5CM Y 1" 1/2 DE
DIÁMETRO.**

Cod. YP-AM10-5

YANPO[®]
ELECTRONIC TECHNOLOGY

**HERRAMIENTAS
PARA
ELECTRÓNICA**

**MICROSCOPIO RF4 ESTÉREO
CON ZOOM TRINOCULAR 6.5X-65X**

AJUSTABLE CON BASE DE REPARACIÓN DE
ALEACIÓN DE ALUMINIO MULTIFUNCIONAL Y
TRINOCULAR GIRATORIO DE 360°

Cod. JV-RF6565TVD2



**MICROSCOPIOS PARA
REPARAR CELULARES**

**MICROSCOPIO RF4
ELECTRÓNICO TRINOCULAR 7-50X**

PARA REPARACIÓN DE TELÉFONOS MÓVILES,
ZOOM CONTINUO 7X A 50X,
TRINOCULAR GIRATORIO DE 360°

Cod. JV-RF7050-P04





**SET DE CINCO
DESTORNILLADORES
PARA REPARACIÓN DE
CELULARES CON MANGO
DE ALUMINIO.**

Cod. JV-041



**SOPORTE UNIVERSAL
PARA REPARAR
CIRCUITO DE CELULAR
PCB 180MM X 90MM**

Cod. JV-TE-079



MICROSCOPIO DIGITAL

usb, 8 luces led y resolución
fotográfica de 1080p compatible con
windows 2000/xp/7/8/10, vista, mac, linux
y con teléfono inteligente android

Cod. JV-1000X

YANIPPO®

Electronic Technology



**ESTACIÓN DE CARGA DE
6 PUERTOS**

cargador rápido usb para teléfono,
tableta, adaptador móvil para el hogar,
estación de carga rápida pantalla led de 6
puertos, 50w. tester usb

Cod. JV-KLW-818



**FUENTE DE PODER DE
30V/5A MECHANIC
DSP30D5**

Fuente de alimentación regulada de
30V y 5A, ideal para laboratorios y
técnicos de servicio.

Cod. JV-DSP30D5



ESTACIÓN PARA SOLDAR LIBRE DE PLOMO

*Método de calentamiento único, control de temperatura constante de 120 ~ 500 °C , temperatura estable, compensación automática de temperatura y control de temperatura preciso.

Cod. JV-T115



ESTACIÓN SOLDADURA REGULABLE CAUTIN MECHANIC / 45W

- *LED Indicador
- *Boton De Encendido
- *Perilla De Control De Temperatura De 200 a 480 °C
- *Viene con su Base Para Apoyo El Cautin
- *Viene con su Cautin de 45 W Con Punta Tradicional Para Taller Electrónico.

Cod. JV-HK-936



ESTACIÓN DE SOLDAR CAUTIN PROFESIONAL MECHANIC T12 DIGITAL

- *Calienta en 4.5 segundos
- *Rango de temperatura es entre los 200 C° y los 450 C°
- *Es pequeña en tamaño y peso lo que la hace portable
- *Precisión inteligente de temperatura mantiene la temperatura indicada.
- *Función inteligente de sueño automaticamente entra en stand by y automaticamente despierta lo que incrementa bastante la vida útil del producto.

Cod. JV-T12PRO



ESTACIÓN SOLDADURA REGULABLE CAUTIN MECHANIC / 60W

- *Con Pantalla Indicadora De Temperatura (LED 7 Segmentos)
- *Boton De Encendido
- *Perilla De Control De Temperatura De 200 a 480 °C
- *Viene con su Base Para Apoyo El Cautin
- *Viene con su Cautin de 60 W Con Punta Tradicional Para Taller Electrónico.

Cod. JV-HK-936D



ESTACIÓN DE AIRE CALIENTE 110V, 750W LED DIGITAL, RANGO DE TEMPERATURA 100°C-500°C

- sensor de circuito cerrado con control de temperatura preciso y estable
- pantalla led y microcomputadora con cruce por cero para calentamiento rápido
- flujo de aire grande, suave y completamente ajustable
- ideal para soldadura sin plomo y múltiples aplicaciones técnicas
- activación automática por sensor en el mango (modo trabajo/espera)
- función de enfriamiento automático que prolonga la vida útil del calentador
- ventilador sin escobillas: larga duración y bajo nivel de ruido

Cod. JV-858D



ESTACIÓN AIRE CALIENTE TEMPERATURA REGULABLE MECHANIC

- *con pantalla indicadora de temperatura (led 7 segmentos)
- *boton de encendido
- *perilla de control de caudal de aire
- *viene con su base para apoyo de pistola
- *botones up y down para control de temperatura.
- *viene con 3 boquillas de uso tradicional.

Cod. JV-HK-859D



ESTACIÓN DE SOLDADURA PARA REPARAR CELULARES MECHANIC 600W

Estación de soldadura de aire caliente con pantalla digital led y control de temperatura preciso (100°C-450°C). Cuenta con núcleo calefactor de cerámica para calentamiento rápido y protección contra sobrecalentamiento. Su ventilador actualizado ofrece flujo de aire suave y silencioso con velocidad ajustable. Incluye tres boquillas intercambiables (10mm, 8mm, 5mm) para distintos trabajos. posee interruptor magnético en espera automático y un diseño ergonómico y compacto, ideal para talleres de reparación.

Cod. JV-957DW



**CAUTÍN DE 40W 110VAC,
PUNTA DE ROSCA**

Cod. YP-40C

14 cm



CAUTIN 30 WATTS

Cod. JV-30C



**TEMPERATURA
AJUSTABLE**



**SOLDADOR DE 60W DE
TEMPERATURA AJUSTABLE**

Cod. JV-K-060W



**PANTALLA
DIGITAL LCD**



**CAUTIN CON TERMOSTATO
DE TEMPERATURA
REGULABLE ALTA
CALIDAD 60W MECHANIC**

Cod. JV-HK-762



29 cm

**CAUTIN PUNTA PLANA
MANGO DE MADERA 100W**

Cod. JV-020A



**PUNTAS PARA CAUTÍN 20
100W**

Cod. JV-PC20-100W



OT-TI

**PUNTA PARA CAUTIN OT
SERIES MECHANIC**

Cod. JV-OT-TI



**PUNTAS PARA CAUTÍN
PLANO Y CURVO 100W,
100% COBRE**

Cod. JV-PC100W



**PUNTA PARA ESTACIÓN DE
SOLDADURA MECHANIC**

Cod. JV-900M-T-I



**BASE PARA CAUTIN
SENCILLA**

Cod. JV-ISD



**BASE PARA
CAUTIN**

Cod. JV-HA007



**SOLDADURA DE ESTAÑO
60/40 - 1/4 LB**

Cod. YP-SD1-4



**SOLDADURA DE ESTAÑO
60/40 - 1/2 LB**

Cod. YP-SD1-2



**ROLLO DE CINTA
CONDUCTIVA**

1.2cm de ancho, 0.05mm de
espesor y 10 mts de largo

Cod. CINTA-C



pure red copper
Plait stitch style braided



**MECHA DESOLDADORA,
ANTIESTATICA - ANCHO 2,0
MM LARGO 1,5 METROS**

Cod. JV-K2015



**MAQUINA REMOVEDORA
DE PEGAMENTO OCA PARA
PANTALLAS LCD MECHANIC**

Cod. JV-IR14



**POLISHING PEN
TODO EN UNO
(REMOVEDOR DE
PEGAMENTO, PULIDOR)**

Cod. JV-W-06



**MINI MOTOR TOOL
RECARGABLE PARA
REPARACIÓN DE
CELULARES 9PCS
MECHANIC**

Cod. JV-IRX8



**DESTORNILLADOR
RECARGABLE**

para reparación de celulares 24pcs

Cod. JV-X-DRIVER



**DESTORNILLADOR PARA
CELULAR +1.5 MECHANIC**

Cod. JV-MAX8



**DESTORNILLADOR
PENTA 0,8**

Cod. JV-043PT08



**CEPILLO REMOVEDOR DE
PEGANTE CON
CERDAS DE ACERO**

Cod. JV-ACBRUSH



CEPILLO REMOVEDOR DE PEGANTE CON CERDAS DE NYLONC

Cod. JV-NYBRUSH



BISTURI CON CUCHILLAS INTERCAMBIABLES PARA REPARAR CELULARES MECHANIC

Cod. JV-IMAX9



MICRO TIJERAS 5" 12.5CM MECHANIC

Cod. JV-TS-190



CORTA FRIO EN DIAGONAL 5" 12.5CM MECHANIC

Cod. JV-TS-X05



PINZA 5" 125MM MECHANIC

Cod. JV-TS-J615



CORTA FRIO DE ALTA PRECISIÓN MECHANIC

Cod. JV-CT50



PINZA MULTIUSOS

Cod. JV-PZ



PINZA RECTA NEGRA - 12CM

Cod. JV-ESD-11



PINZAS DE ACERO INOXIDABLE PUNTA RECTAS 157MM

Cod. JV-KW-11C



PINZAS DE ACERO INOXIDABLE CON PUNTA CURVA 159MM

Cod. JV-KW-15C



LIMPIACONTACTOS ELECTRONICO

BIODEGRADABLE
SIN DESTILADO DE PETROLEO
SIN SOLVENTES CLORADOS

Cod. JV-AZ530



LIMPIACONTACTOS ELECTRONICO 550ML

BIODEGRADABLE
SIN DESTILADO DE PETROLEO
SIN SOLVENTES CLORADOS

Cod. JV-AM530



TERCERA MANO TRES BRAZOS

Cod. JV-TE805



BASE LUPA 10X CON LUZ LED

Cod. JV-10X



PISTOLA DE AIRE CALIENTE

- rango de temperatura de 60-600°C,
- potencia: 2000w flujo de aire:
- 300-500l/min, 110v

Temperatura ajustable de dos velocidades, primera velocidad 60-400°C, segunda velocidad 400-600°C.

Flujo de aire ajustable de dos velocidades, primera velocidad 250 L/min, segunda velocidad 550 L/min.

Cod. JV-855B

PANTALLA DIGITAL LCD



PISTOLA DE AIRE CALIENTE,

- pantalla digital lcd doble
- rango de temperatura 40°-400° de 60°-600°C,
- potencia: 2500w
- flujo de aire: 300-500l/min, 110v

Temperatura ajustable de dos velocidades, primera velocidad 60-400°C, segunda velocidad 400-600°C.

Flujo de aire ajustable de dos velocidades, primera velocidad 250 L/min, segunda velocidad 550 L/min.

Cod. JV-855A

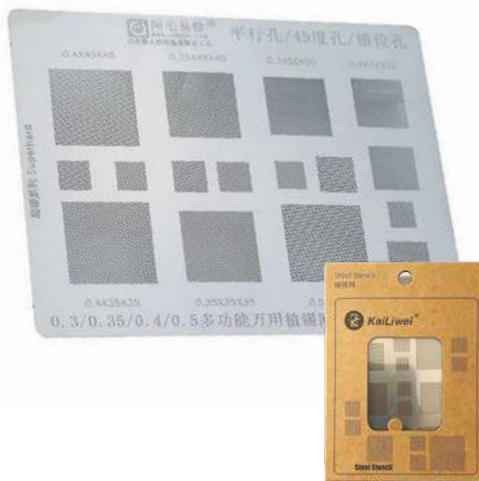

BASE DE ALUMINIO PARA MICROSCOPIO DE 410X300MM

Cod. JV-20B

PLANTILLA DE ACERO USADO EN REPARACION DE CELULARES - 16 EN 1

Cod. JV-PLA-161

TAPETE DE TRABAJO

para reparar celulares flexible antiestática 45x30cm silicona

Cod. JV-V63



TAPETE REPARACION CELULAR ANTIESTATICO 200X250X8MM

Cod. JV-MT-ROJO



SOPORTE PARA CELULAR TIPO CHUPA NEGRO MECHANIC

Cod. JV-OCTPN



SOPORTE PARA CELULAR TIPO CHUPA BLANCO MECHANIC

Cod. JV-OCTPB



ORGANIZADOR
MULTIFUNCIONAL
MECHANIC

Cod. JV-B24



ORGANIZADOR DE
HERRAMIENTAS PARA
REPARAR CELULARES

Cod. JV-MT-BR10



ORGANIZADOR PLASTICO
DE 12 ESPACIOS

Cod. JV-OR-521



ORGANIZADOR PLASTICO
DE 22 ESPACIOS

Cod. JV-OR-510



ORGANIZADOR
PLASTICO DE 18 ESPACIOS

Cod. JV-OR-503



ORGANIZADOR PLASTICO
DE 60 ESPACIOS

Cod. JV-OR-504



MULTIMETRO DIGITAL

SIN BUZZER

Cod. JV-DT-830B



MULTÍMETRO ANÁLOGO YX-360TR NO INCLUYE BATERIA

Cod. JV-YX-360TR



MULTÍMETRO DIGITAL DT9205A NO INCLUYE BATERIA

con función para transistores
Cod. JV-DT9205A



MULTÍMETRO DIGITAL PORTÁTIL CON PANTALLA DIGITAL. NO INCLUYE BATERIA

rango de corriente de medición
dca:20ua-20a aca:20ma-20a y rango de
voltaje de medición
cc: 200 mv-1000 v/ca: 2 v-750 v

Cod. JV-890C



PUNTAS PARA MULTIMETRO

Cod. DGT-9228



PUNTAS MULTIMETRO, CON PUNTAS BANANA

Cod.DGT-9212



**PUNTAS PARA
MULTIMETRO 10A**

Cod. JV-PPM



**PUNTAS BANANA
PINZAS DE PRUEBA
MULTÍMETRO CAIMAN**

Cod. DGT-9227



PUNTAS PARA TESTER

Cod. JV-BPPM2



CAIMAN CON CABLE 1M

Cod. JV-CAIMAN1M



**JUEGO DE 10 CAIMANES EN
COLORES SURTIDOS**

Cod. YP-CAMX10



**CAIMÁN PARA BATERÍA
METÁLICO 200AMP ROJO
Y NEGRO.**

POR UNIDAD (1)

Cod. YP-CM200A

SIRVE PARA RECARGAR
JUGUETES CON BATERIA



CARGADOR DE BATERIAS 12V - 6 AMP

Carga Inteligente y Segura: Protege contra sobrecargas, sobredescargas, cortocircuitos y sobrecalentamientos para una mayor seguridad en cada carga.

Modos de Temporada: Ajuste automático del voltaje según la temperatura, con modos de invierno y verano para una carga óptima.

Reparación de Baterías Viejas: La función de reparación ayuda a recuperar la capacidad de baterías dañadas, extendiendo su vida útil.

Carga Rápida y Potente: Ofrece una salida de corriente de hasta 6A y un voltaje de 12V proporcionando una carga rápida y efectiva.

Cod. JV-WA-1

YANIPO[®]
Electronic Technology



INVERSOR DE VOLTAJE 12V-110V 800W

Cod. JV-WA-3

HERRAMIENTAS



DESTORNILLADOR
ESTRELLA PH1
4X75MM (3")

PUNTA IMANTADA

Cod. JV-SL4-4X75



DESTORNILLADOR
ESTRELLA PH1
5X75MM (3")

PUNTA IMANTADA

Cod. JV-SL5-5X75



DESTORNILLADOR
ESTRELLA PH2
6X75MM (3")

PUNTA IMANTADA

Cod. JV-SL6-6X75



DESTORNILLADOR
ESTRELLA PH1
4X150MM (6")

PUNTA IMANTADA

Cod. JV-SL4-4X150



DESTORNILLADOR
ESTRELLA PH1
5X150MM (6")

PUNTA IMANTADA

Cod. JV-SL5-5X150



DESTORNILLADOR
ESTRELLA PH2
6X150MM (6")

PUNTA IMANTADA

Cod. JV-SL6-6X150

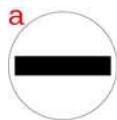

DESTORNILLADOR PALA
4X75MM (3")

PUNTA IMANTADA

Cod. JV-PH1-4X75

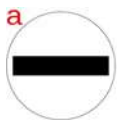

DESTORNILLADOR PALA
5X75MM (3")

PUNTA IMANTADA

Cod. JV-PH1-5X75

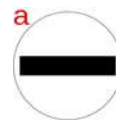

DESTORNILLADOR PALA
6X75MM (3")

PUNTA IMANTADA

Cod. JV-PH2-6X75

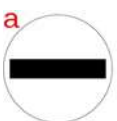

DESTORNILLADOR PALA
4X150MM (6")

PUNTA IMANTADA

Cod. JV-PH1-4X150

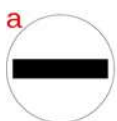

DESTORNILLADOR PALA
5X150MM (6")

PUNTA IMANTADA

Cod. JV-PH1-5X150

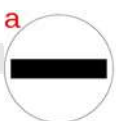

DESTORNILLADOR PALA
6X150MM (6")

PUNTA IMANTADA

Cod. JV-PH2-6X150



DESTORNILLADOR TORX T5
3X75MM (3")

PUNTA IMANTADA

Cod. JV-T5-3X75

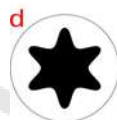

DESTORNILLADOR TORX T6
3X75MM (3")

PUNTA IMANTADA

Cod. JV-T6-3X75



DESTORNILLADOR TORX T8
3X75MM (3")

PUNTA IMANTADA

Cod. JV-T8-3X75



BISTURI MANGO GOMA FINO

Cod. JV-KF1



JUEGO DE PINZAS 4 IN 1

Cod. JV-SETPZ

**PAQ.
X 6unds**



**CINTA ADHESIVA
TRANSPARENTE 100M X
6UNDS**

Cod. JV-TP4-55X100



**CINTA METRICA 3 METROS
10FT 16MM**

Cod. JV-MT3M



**CINTA METRICA 5 METROS
10FT X 19MM**

Cod. JV-MT5M



9 copas mm de 5mm a 9mm

**SET DE DESTORNILLADOR
MULTIUSO**

Cod. JV-9903



**JUEGO DESTORNILLADOR
INTERCAMBIABLE 6 EN 1**

PH0-3.0, PH1-4.0, PH2-5.0

Cod. JV-9906



**JUEGO DESTORNILLADOR
INTERCAMBIABLE
10 PUNTAS**

Cod. JV-9902



**JUEGO DE
DESTORNILLADORES
31 EN 1**

Cod. JV-6036-A



**JUEGO DE
DESTORNILLADORES
30 EN 1 SIN EXTENSOR**

Cod. JV-6032-A



**JUEGO DE
DESTORNILLADORES
32 EN 1**

Cod. JV-1032



**KIT
DESTORNILLADORES
32 PIEZAS CON EXTENSOR**

Cod. JV-TE-6032



JUEGO DE DESTORNILLADORES 12 EN 1

CON COPAS MM PH0-SL3.0, T7-SL2.0, T8-
T5, T10-T6, T15-U2.3

Cod. JV-6613B



JUEGO DE DESTORNILLADORES INTERCAMBIABLES 6 EN 1

Cod. JV-SW-1020



SET DE DESTORNILLADOR 6 PUNTAS DOBLES

PH000-1.5, PH00-1.8,
Y2.0-Y3.0, T2-T4

Cod. JV-7395B



JUEGO DE DESTORNILLADORES 32 EN 1

Cod. JV-7389C



10 cm

6 cm



SET DE DESTORNILLADOR 6 PUNTAS DOBLES

Juego de destornilladores multifuncionales,
dispositivo de destornillador hexagonal triangular
cruzado de forma especial con alta dureza

Cod. JV-6011

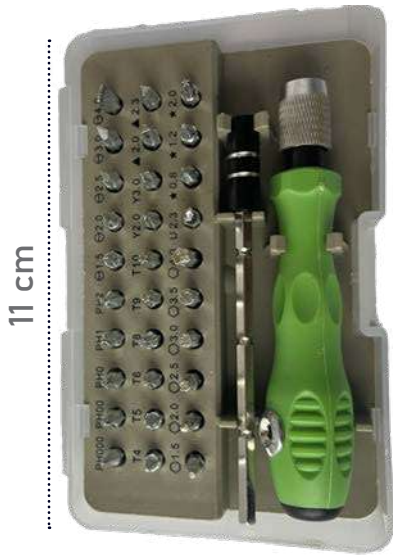

11 cm

7 cm

SET DE DESTORNILLADOR 32 IN 1 FINO

Cod. JV-6011A



SET DE DESTORNILLADOR 52 EN 1

CON COPAS MM 2.5-5.5, Y0.6 Y2.0 Y2.5, U2.6 00.8

Cod. JV-52



SET DE DESTORNILLADOR 115 EN 1

SIM, M2.5-M5.5, Y0.6-Y3.0 U2.3-U2.6, MID, PZ000-PZ2

Cod. JV-KT152

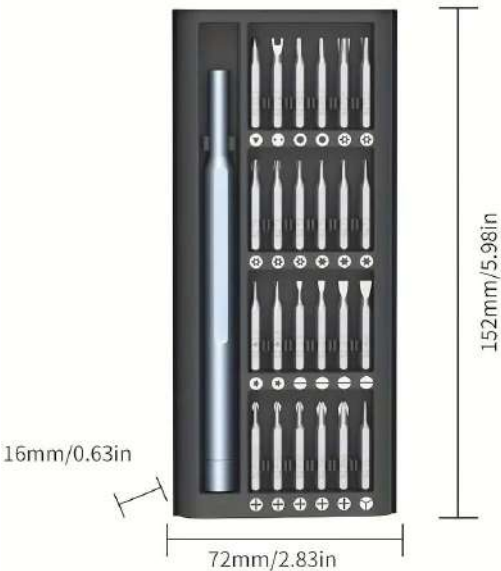

16mm/0.63in

72mm/2.83in

152mm/5.98in

JUEGO DE DESTORNILLADORES 24 IN 1

Cod. JV-24



JUEGO DE HERRAMIENTAS 119 EN 1

CON COPAS MM PH000-PH2, OSIM, Y0.6-Y3.0

Cod. JV-119



JUEGO DE DESTORNILLADORES 124 EN 1

CON COPAS MM OSIM, +MID, Y0.6-Y3.0, PH2

Cod. JV-124



KIT DE DESTORNILLADOR MAGNÉTICO RETRÁCTIL 41 EN 1

CON COPAS MM 2.5-5.5, Y1 Y2,
U2.3 U2.6, T10-T40

Cod. JV-41



SET DE DESTORNILLADOR PARA CELULAR 25 PCS

Cod. JV-XW-6025



JUEGO DE 5 DESTORNILLADORES DE PRECISIÓN 5234

Cod. JV-5234



JUEGO DE 5 DESTORNILLADORES DE PRECISIÓN

Cod. JV-3688



JUEGO DE 6 DESTORNILLADORES DE PRECISIÓN

Cod. JV-680



JUEGO BISTURI 7 PIEZAS

Cod. JV-7BLADE



JUEGO DE HERRAMIENTAS PARA DESARMAR

Cod. JV-SW-X1468



JUEGO DE HERRAMIENTAS PARA DESARMAR

Cod. JV-1476



ESPATULAS PARA DESARMAR CELULAR 5PCS

Cod. JV-TE-018



PALETAS DE DESARMAR CELULARES / 10 UNIDADES

Cod. JV-TE-05



PALETAS PARA DESARMAR CELULARES, PUNTA METALICA 6 UNIDADES

Cod. JV-TE-06



SET DE DESTORNILLADORES DE PRECISION 8 PCS

Cod. JV-2811



- ⊕ T5-50
- ⊕ T6-50
- ⊕ 1.5-50
- ⊕ 2.0-50
- ⊕ 2.5-50
- ⊖ 2.0-50
- ⊖ 0.8-50
- ⊖ 1.2-50
- ⊖ 2.5-50
- ⊖ 0.6-50

SET DE DESTORNILLADORES PARA CELULAR 10 PCS

Cod. JV-SW-6124



JUEGO DE HERRAMIENTAS 75 EN 1

CON COPAS MM PH000-PH2, 00.8, Y0.6-Y3.0, U1.7-U8

Cod. JV-SW-8152



JUEGO DE HERRAMIENTAS 170 EN 1

CON COPAS MM 00.8-01.0, Y0.6-Y3.5, W1.5-W2.5

Cod. JV-170SL



JUEGO DE 8 DESTORNILLADORES

CON COPAS MM PH1, PH2, PH3

Cod. JV-8924



JUEGO DE DESTORNILLADORES 26 EN 1

CON COPAS MM PH0-PH2, Y1-Y2, T10-T30, S2-S3.5, H3-H5, U2.6

Cod. JV-3017



LUPA CON MANGO

Cod. JV-LJ-009



**TESTER RED
ECONOMICO
RJ45-RJ11**

Cod. JV-TE-RED



**PROBADOR DE CABLE
HDMI Y RJ45**

Cod. JV-TE-HDMI



**PELACABLE
ROTATIVO**

Cod. JV-PCT



**PONCHADORA DE
IMPACTO TIPO KRONE**

Cod. JV-KD-1



**PONCHADORA DE
IMPACTO RJ45 HT-314B**

Cod. JV-HT-314B



**KIT PONCHADORA
RJ45 / RJ11 +
PELACABLE**

Cod. JV-OB-315



**PONCHADORA PARA
RJ 45 / RJ11**

Cod. JV-HT-568



**PONCHADORA
RJ45 / RJ11 AZUL+ FINA**

Cod. JV-SK-868G



**PONCHADORA PARA
CONECTORES RJ45 Y RJ11**

ESPECIALES PARA PASS
THROUGH

Cod. JV-PCH



**PONCHADORA PARA
CONECTOR RJ45 CAT 5 CAT
6 CAT 7**

ESPECIALES PARA PASS
THROUGH

Cod. JV-PCHCAT7



19 cm

DESOLDADOR

Cod. JV-HX007



33 cm

DESOLDADOR PLÁSTICO

Cod. JV-AX-108



ALICATE DE CRIMPADO

Cod. JV-SN-02C



CORTA FRIO

6"/150mm

Cod. JV-CF6



CORTA FRIO

6"/125mm

Cod. JV-5CUT



CORTA FRIO

6"/130mm

Cod. JV-DT-109



PINZA

6"/150mm

Cod. JV-PZ6



ALICATE

6"/150mm

Cod. JV-ALT6



**SIRENA DE MOTOR
VOLÚMEN DE SONIDO
40W**

Cod. YP-SIRE40



**SIRENA DE 1 TONO
PARA 6 DC VOLTS DE
15 WATTS. REDONDA DE
2 1/4".**

Cod. YP-SIRE15

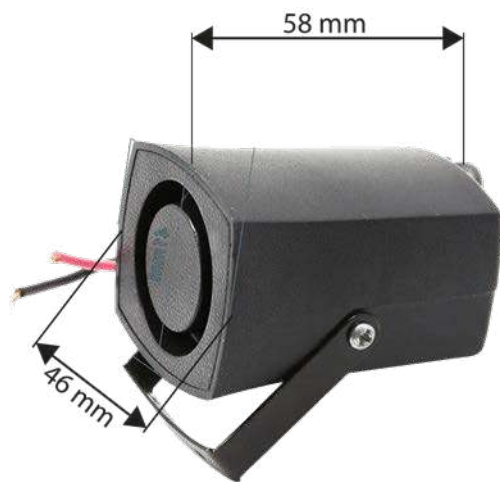

**SIRENA DE ALARMA PARA
6/12 DC VOLTS - 10 WATTS**

Cod. YP-SICU10



**SIRENA DE 1 TONO
PARA 6/12 DC
VOLTS. 10 WATTS.
REDONDA**

Cod. YP-SIRE10



**SIRENA 6 TONOS
6-12V DC**

Cod. JV-SRA1



**SIRENA 2 TONOS
6-12V**

Cod. JV-SRA2

 **Llegó**

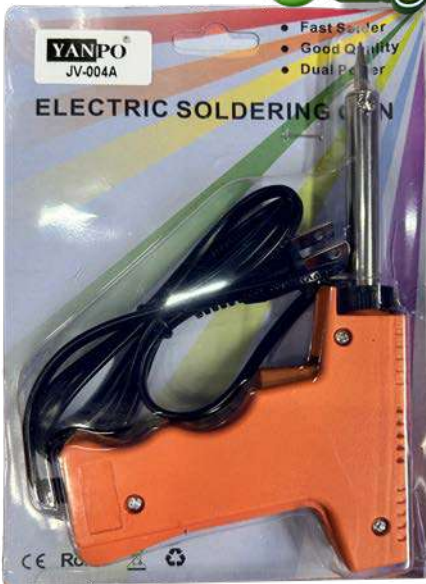

**CAUTIN TIPO PISTOLA
100W**

Cod. JV-004A



**PISTOLA PARA BARRA
DE SILICONA DELGADA
20W**

Cod. JV-005



**PISTOLA PARA BARRA
SILICONA GRANDE 40W**

Cod. JV-014

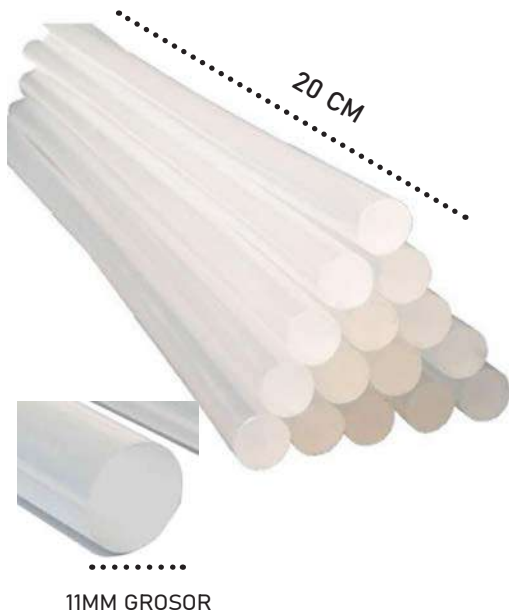

**BARRAS DE SILICONA
11*200MM**

Cod. JV-BS11X200

"KILO X 52 UNDS - VALOR UND : \$632"

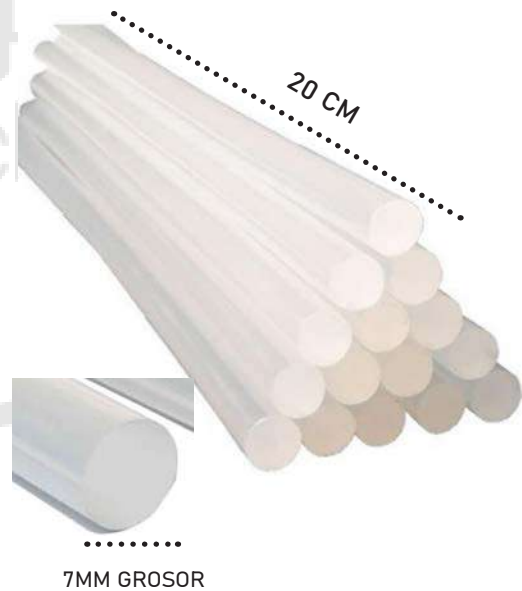

**BARRAS DE SILICONA
7*200MM**

Cod. JV-BS7X200

"KILO X 130 UNDS - VALOR UND : \$253"



10 CM

ANTENA TDT DE 10 CM
CON CABLE 1.5M

Cod. JV-AN14



12 CM

11 CM

ANTENA
INTERCAMBIABLE

ANTENA TDT
CON CABLE 3M

Cod. JV-ATDT-3M



10.5 CM

ANTENA PARA TDT CON
CABLE 5M - ECO

Cod. JV-AT5M



11.5 CM

ANTENA TDT
CON CABLE 5M

Cod. JV-ATDT-5M



11.5 CM

ANTENA TDT
CON CABLE 5M

Cod. JV-043



13 CM

ANTENA TDT CON
CABLE 5M



Amplificador de Señal
Alimentado por USB

Cod. JV-DVBT2-5M

PRECIO ESPECIAL



**ANTENA PARA EXTERIOR DE
16 ELEMENTOS HDTV CON
10MT DE CABLE**

Cod. JV-521J8

PRECIO ESPECIAL



**ANTENA PARA EXTERIOR DE
8 ELEMENTOS HDTV CON
10MT DE CABLE**

Cod. JV-329D4

PANEL SOLAR Y LINTERNAS



PANEL SOLAR 15W CON CABLE USB Y CAIMANES

Cod. JV-CL-1615



PANEL SOLAR 20W CON CABLE USB Y CAIMANES

Cod. JV-CL-1825

PRECIO EXCENTO DE IVA

PRECIO EXCENTO DE IVA

MEDIDAS 30X30X3

MEDIDAS 30X30X4

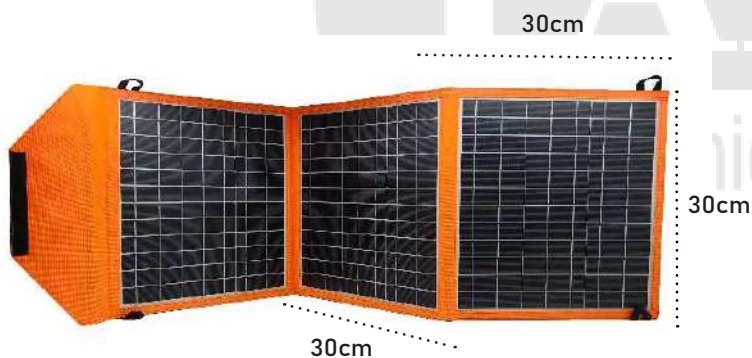

PANEL SOLAR 30W TIPO FOLDER X3

Cod. JV-CL-ZD1830

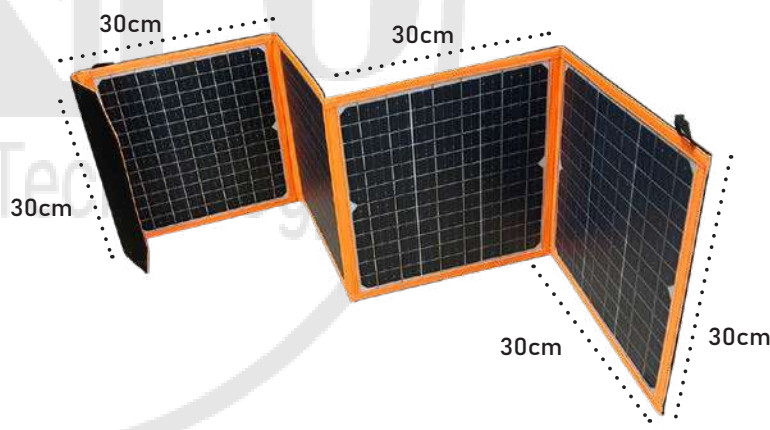

PANEL SOLAR 40W TIPO FOLDER X4

Cod. JV-CL-ZD1840

PRECIO EXCENTO DE IVA

PRECIO EXCENTO DE IVA

PRODUCE CARGA PARA:

PRODUCE CARGA PARA:



CAMARA 5V



TELEFONO 5V



CAMARA 5V



TELEFONO 5V



VENTILADOR SOLAR RECARGABLE 6"
CON PANEL SOLAR Y 1 LUZ

Cod. JV-GD-8025



VENTILADOR SOLAR RECARGABLE 7"
CON PANEL SOLAR Y 1 LUZ

Cod. JV-GD-8021



VENTILADOR SOLAR RECARGABLE 8"
CON PANEL SOLAR Y 1 LUZ

Cod. JV-GD-8027



VENTILADOR SOLAR RECARGABLE 12"
CON PANEL SOLAR Y 2 LUCES

Cod. JV-GD-8012



LINTERNA PARA COLGAR
CON GANCHO 50W

Cod. JV-CL023-50



LINTERNA PARA COLGAR
CON GANCHO 80W

Cod. JV-CL023-80



VENTILADOR SOLAR RECARGABLE 16"
CON PANEL SOLAR Y 2 LUCES

Cod. JV-GD-956



**TIMBRE DE LA PUERTA
CON SENSOR DE
MOVIMIENTO**

Cod. YP-ANGU

-25%

Llegó



**TIMBRE INALAMBRICO
16 TONOS**

Cod. JV-TM-16S

-10%



**MEGAFONO PORTABLE
PEQUEÑO USB**

Cod. JV-619U

22 cm

7 cm



16 cm

4cm

**LINTERNA CON
CARGADOR SOLAR**

Cod. JV-CL-058

14cm



19 cm

**LINTERNA SOLAR CON
MANIJA CARGADOR PARA
CELULAR**

Cod. JV-HB-9707A-1

11cm



17cm

**LINTERNA DE TRABAJO
SOLAR/USB/CARGADOR
PARA CELULAR**

Cod. JV-JY-819A

MÁQUINAS PARA CORTAR CABELLO

Kemei®
KM-802



MAQUINA PARA CORTAR CABELLO
KEMEI DE 10W

Cod. JV-KM-802

Kemei



MAQUINA PARA CORTAR CABELLO KEMEI
BLANCA DE 5W

Cod. JV-KM-PG809A

HTC®



PATILLERA RECARGABLE
DE 3W

Cod. JV-AT-528A

HTC®



MAQUINA PELUQUERIA
RECARGABLE DE 5W

Cod. JV-CT-8088



MAQUINA PELUQUERIA
RECARGABLE DE 5W

Cod. JV-KM-PG1990A



MÁQUINA PARA CORTAR CABELLO PROFESIONAL

CON INDICADOR DE CARGA, CUCHILLAS CROMADAS DE ALTA PRECISIÓN, PALANCA DE AJUSTE, RECARGABLE

Cod. JV-S-3139



MÁQUINA DE AFEITAR DOBLE HOJA PARA HOMBRE, RECARGABLE.

CUERPO COMPLETO LAVABLE, MALLA DOBLE DE ACERO INOXIDABLE. LA PANTALLA LCD MUESTRA LA ENERGÍA RESTANTE.

Cod. JV-SH-7116



MÁQUINA PARA CORTAR CABELLO PROFESIONAL

CON CUERPO METÁLICO ANTIDESLIZANTE, DISEÑO ÚNICO, PANTALLA DIGITAL, RECARGABLE.

Cod. JV-SH-2690



MÁQUINA PARA CORTAR CABELLO PROFESIONAL

CON LAMPARA INDICADORA, RECARGABLE.

Cod. JV-SH-1943



USB TIPO C



BATERIA
2000mAh



INDICADOR LED



2 HORAS DE CARGA



MAQUINA PARA CORTAR CABELLO
CON INDICADOR DE BATERIA

Cod. JV-S-1439



Tipo C



ASPIRADORA MANUAL RECARGABLE
PARA CARRO

Cod. JV-KM-34



DEPILADORA SIN DOLOR

PARA AXILAS, PIERNAS Y LÍNEA DE BIKINI,
INALÁMBRICA Y RECARGABLE.

Cod. JV-S-7678



MÁQUINA REMOVEDOR DE PELUSA PARA USO
DOMÉSTICO, RECARGABLE

RECARGABLE

Cod. JV-S-3944

SOPORTES TV



NON-SLIP GRIPS EASY TO ADJUST

**SOPORTE PARA
DECODIFICADOR**

Cod. JV-Q33



**SOPORTE DE TECHO PARA
VIDEO BEAM**

Cod. JV-PDS08-65/W



**BASE MONITOR 14 A 30"
90°**

Cod. JV-BSMT

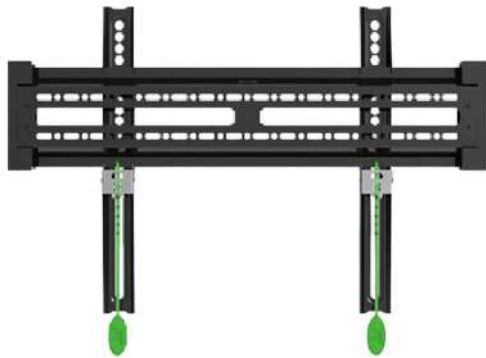

PESO DE BASE 1Kg

**SOPORTE FIJO PARA TV
DE 26" A 60"**

ANGULO +12/-0 SOPORTA 40KG

Cod. JV-D2-F



PESO DE BASE 1.3Kg

**SOPORTE FIJO
PARA TV DE 32" A 65"**

ANGULO +12/-0 SOPORTA 50KG

Cod. JV-C2-F

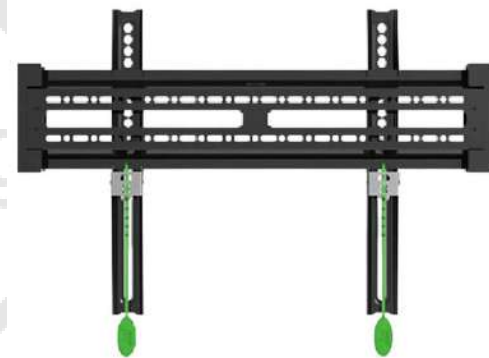

PESO DE BASE 1.5Kg

**SOPORTE FIJO
PARA TV DE 42" A 75"**

ANGULO FIJO
SOPORTA 56.8KG

Cod. JV-C3-F

SOPORTES PARA T.V



PESO DE BASE
1.9Kg

SOPORTE RECLINABLE PARA TV DE 26" A 60"

ANGULO +12/-0
SOPORTA 40KG

Cod. JV-C2-T



PESO DE BASE
2Kg

SOPORTE RECLINABLE PARA TV DE 32" A 70"

ANGULO +12/-0
SOPORTA 56.8KG

Cod. JV-C3-T

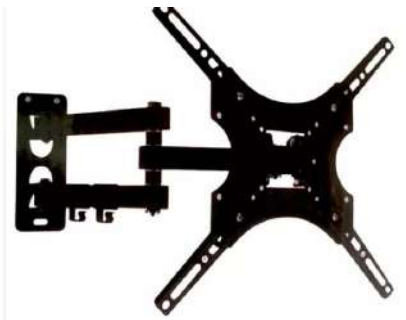

PESO DE BASE
1.5Kg

SOPORTE CON BRAZO PARA TV DE 32" A 55" X-400

ANGULO -15 /+ 15
SOPORTA 22KG

Cod. JV-X400



PESO DE BASE
4Kg

SOPORTE CON DOBLE BRAZO PARA TV DE 32" A 60"

ANGULO -15/+15
SOPORTA 41KG

Cod. JV-P5-L400



PESO DE BASE
6Kg

SOPORTE CON DOBLE BRAZO PARA TV DE 32" A 70"

ANGULO -15/+15
SOPORTA 50KG

Cod. JV-777-L400

MÁS PUERTOS, MÁS POSIBILIDADES:

Descubre nuestros HUB

-12%



USB
H2.0

HUB 4 PUERTOS CON SWITCHS

Cod. JV-HUB-4



USB
H2.0

HUB 4 PUERTOS

presentación en blíster.

Cod. JV-HUB44

USB
H2.0



HUB 4 PUERTOS CIRCULAR

Presentación en blíster.

Cod. JV-BYL-1810



USB
H2.0

HUB 4 PUERTOS

Cod. JV-303



COLORES



USB
H2.0

HUB 4 PUERTOS

Cod. JV-HUB41

-8%

SUPER SPEED
USB
H3.0



HUB 7 PUERTOS V 3.0

VELOCIDAD 3.0

Cod. JV-HUB7-V3

Antes
~~\$29.800~~

INCLUYE:
CABLE USB DE
ALIMENTACIÓN



HUB 7 PUERTOS CON PUERTO 3.0

VELOCIDAD 3.0

Cod. JV-HUB703-3R



TIPO
LIGHTNING



HUB TIPO IPHONE / 2 USB + PD

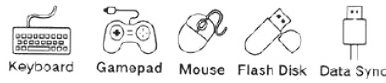

Cod. JV-HUB310



HUB TIPO C 3.0 +PD 5 EN 1

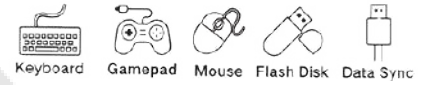

Cod. JV-HUB500



TIPO USB



HUB USB 3.0 +PD 5 EN 1

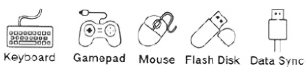

Cod. JV-HUB510



HUB 7 PUERTOS CON SWITCH

presentación en blíster.

Cod. JV-P-1602



HUB 10 PUERTOS

presentación en blíster

Cod. JV-HUB10

CINTA LED 5050 MÁGICA IP67 CON CONTROL MINI Y ADAPTADOR

5mts

Cod. JV-MAGIC-MINI



IP67
Waterproof



Silicone Casing Protection

Incluye: Cinta RGB IP67 Mágica, Control, Adaptador de Voltaje, son resistentes a la intemperie.

NPO[®]

Electronic Technology

PIDE A TU ASESOR QUE TE ENVIE SUS VIDEOS





CONTROL TIPO
DIMER PARA CINTA LED
DE UN SOLO COLOR

Cod. JV-CTR-COLOR



CONTROL MINI PARA
CINTA LED MAGICA O
INTELIGENTE

Cod. JV-CTR-MM



CONTROL MINI RGB WIFI
COMPATIBLE CON CELULAR

Y con cualquier cinta RGB que
ya tengan cada uno en su casa
o negocio

Cod. JV-MINIRGB-RF

TIPO PESADO



ADAPTADOR DE
VOLTAJE 12V-5A
5.5x2.5

Cod. JV12V5A



Cinta led de
5 metros

Luz led
RGB

Control Remoto
24 teclas

Bajo consumo
de energia

CINTA LED DE COLORES CON CONTROL
ROLLO X 5 METROS
IP65 VIENE CON CONECTOR DC
NO INCLUYE ADAPTADOR DE VOLTAJE

Cod. JV-CTRGB



IP20

sin silicona
para uso
de vitrina

CINTA LED 5050 IP20
5 METROS BLANCO CALIDO

Cod. JV-CT5050-IP20WW



YANIPPO

Electronic Technology



IP65

Para uso
exterior



CINTA LED 5050 IP65
5 METROS AMARILLA

Cod. JV-CT5050-AMA

IP20

sin silicona
para uso
de vitrina



CINTA LED 5050 IP20
5 METROS BLANCA

Cod. JV-CT5050-IP20WHITE

YANPO[®]



Neón Flex
VENTA AQUI



ROLLO
DE 5 METROS



\$18.800
PRECIO MAS IVA

CINTA DE NEON

FLEXIBLE x 5mts



CINTA LED DE NEON
FLEXIBLE 5M
12V-6X12MM

ROSADA

Cod. JV-NEON-PINK



CINTA LED DE NEON
FLEXIBLE 5M
12V-6X12MM

MORADA

Cod. JV-NEON-PURPLE



CINTA LED DE NEON
FLEXIBLE 5M
12V-6X12MM

DORADO

Cod. JV-NEON-GOLDEN

CINTA DE LED

COB x 5mts



CINTA DE LED COB 5M
IP20-8MM

BLANCO

Cod. JV-COB-WHITE



CINTA DE LED COB 5M
IP20-8MM

BLANCO CALIDO

Cod. JV-COB-WW



CINTA DE LED COB 5M
IP20-8MM

ROSADA

Cod. JV-COB-PINK



CINTA DE LED COB 5M
IP20-8MM

DORADO

Cod. JV-COB-GOLDEN

QUEREMOS ACLARAR UNA DUDA FRECUENTE:



Las pilas **YANPO** vienen en blister y se facturan en blister

Por ejemplo, las pilas CR1220, CR2016, CR2025 y CR2032 vienen en un blister de 5 unidades, como lo muestra la imagen de referencia del lado derecho.

Por tanto, cuando te facturamos un blister, te llegan 5 unidades de una misma referencia.

Las referencias SR621, SR626, LR1130, LR41 y LR44 vienen en un blister de 10 unidades. Por tanto, cuando te facturamos un blister, te llegan 10 unidades de una misma referencia.



NO VIENEN CARGADAS

**PILAS AAA
RECARGABLES 1000MAH**

COD. JV-RAAA



26mm

**NO VIENEN
CARGADAS**

**PILA RECARGABLE
ICR 26650
6800MAH / LI ION 3.7V**

Cod. JV-26650



1 BLISTER CONTIENE 10 PILAS

**AG4 LR626 377 SR626
BLISTER BATERIA 626**

COD. JV-SR626

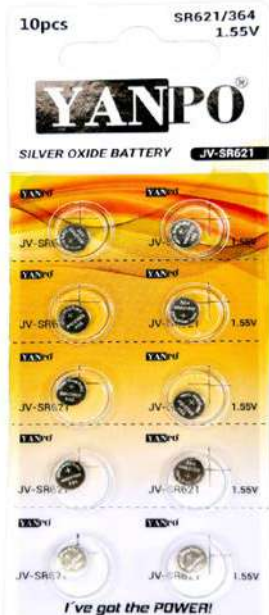

1 BLISTER CONTIENE 10 PILAS

**AG1 364 LR621 SR621
BLISTER BATERIA 621**

COD. JV-SR621

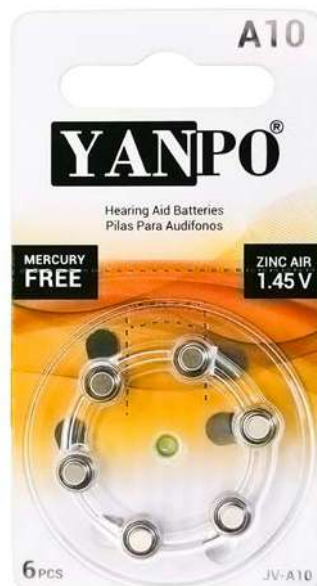

1 BLISTER CONTIENE 10 PILAS

**AG10 LR1130 369 SR1130
BLISTER BATERIA PARA
AUDIFONO A10 ZINC AIR 1.45V**

COD. JV-A10

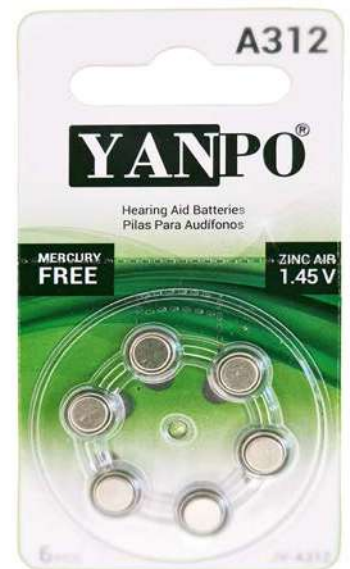

1 BLISTER CONTIENE 10 PILAS

**AP312 AC312 312HP DA312
BLISTER BATERIA PARA
AUDIFONO A312 ZINC AIR 1.45V**

COD. JV-A312



1 BLISTER CONTIENE 5 PILAS

**PILAS CR123A LITHIUM 3V
1500MAH
COD. JV-CR123A**



**PILAS CR1220
COD. JV-CR1220**



1 BLISTER CONTIENE 5 PILAS

**PILAS CR2016
COD. JV-CR2016**



1 BLISTER CONTIENE 5 PILAS

**PILAS CR2025
COD. JV-CR2025**



1 BLISTER CONTIENE 10 PILAS

**PILAS LR1130 ALCALINAS
COD. LR1130**

Energía Inteligente y Segura

Soluciones de Carga Avanzada YANPO: La unión perfecta entre potencia, versatilidad y protección de grado profesional.

Cargador Universal Inteligente

Conexión USB Tipo C de alta eficiencia



Compatibilidad

Li-ion 18650, 14500,
16340, 26650

Entrada

5V / 2A (USB-C)

Salida

4.2V | 500-1000mA
por ranura

Cod. JV-C2

Cargador Especializado AC

Conexión directa a red eléctrica 110V



Compatibilidad

Li-ion 18650

Entrada

110V AC (DIRECTO)

Salida

2 Ranuras
Independientes 4.2V
Estabilizado

Cod. JV-C1

YANPO[®]
ELECTRONIC TECHNOLOGY



SPEAKER



Parlante Bluetooth portátil

Micrófono inalámbrico y control 40W
Luz LED / TF Card / Aux / USB / FM / 2 Mic IN

Cod. JV-DR8832

40 W

Incluye:



61 cm

25 cm



VISTA SUPERIOR



VISTA POSTERIOR



AGARRE RETRACTIL



40W



3600 mAh



Luces LED ritmicas



Bluetooth 5.0



Interfaz: BT, FM, SD Y USB



68 CM

25 CM

40 W

INCLUYE:



VISTA SUPERIOR

Parlante Bluetooth 8"x2

Micrófono inalámbrico y control 40W / Luz led / TF card / Aux / USB / Tipo C / FM / Mic in / TWS



Función TWS



6000 mAh



Luces LED ritmicas



Bluetooth 5.0



Interfaz: BT, FM, SD Y USB

Cod. JV-ZQS8223



68 CM

25 CM

40 W

INCLUYE:



VISTA SUPERIOR

Parlante Bluetooth 8"x2

Micrófono inalámbrico y control 40W / Luz led / TF card / Aux / USB / Tipo C / FM / Mic in / TWS



Función TWS



6000 mAh



Luces LED ritmicas



Bluetooth 5.0



Interfaz: BT, FM, SD Y USB

Cod. JV-ZQS8222



79 CM

24 CM

40 W

INCLUYE:



VISTA SUPERIOR



VISTA POSTERIOR

Parlante Bluetooth 8"x2

Micrófono inalámbrico y control 40W / Luz led / TF card / Aux / USB / Tipo C / FM / Mic in / TWS



Función TWS



4500 mAh



Luces LED ritmicas



Bluetooth 5.0



Interfaz: BT, FM, SD Y USB

Cod. JV-ZQS8221



-5%



93.7 cm

30.5 cm

40 W

Incluye:



VISTA SUPERIOR



VISTA POSTERIOR

Parlante Bluetooth 8"x2

Micrófono inalámbrico y control 40W / Luz led / TF card / Aux / USB / Tipo C / FM / Mic in / TWS



20W*3



4500 mAh



Luces LED ritmicas



Bluetooth 5.0



Interfaz: BT, FM, SD Y USB

Cod. JV-ZQS8301



58 CM

23 CM

20 W

Parlante Bluetooth 8.5"x2

INCLUYE:

Micrófono con Cable y control / 20W / Luz led / TF card / Aux / USB / Tipo C / FM / Mic in



20W



2400 mAh



Luces LED ritmicas



Bluetooth 5.0



Interfaz: BT, FM, SD Y USB

Cod. JV-TTD-2806



38 CM

17 CM

20 W

Parlante Bluetooth 4"x2

INCLUYE:

Micrófono con Cable y control / 20W / Luz led / TF card / Aux / USB / Tipo C / FM / 2 Mic in / Hands Free / TWS



Función TWS



3000 mAh



Luces LED ritmicas



Bluetooth 5.0



Interfaz: BT, FM, SD Y USB

Cod. JV-JQS4401



VISTA SUPERIOR



34 CM

22 CM

20 W

Parlante Bluetooth 8"

Micrófono con Cable y control / 20W / Luz led / TF card / Aux / USB / Tipo C / FM / Mic in

INCLUYE:



20W



1800 mAh



Luces LED ritmicas



Bluetooth 5.0



Interfaz: BT, FM, SD Y USB



Cod. JV-TTD-5804



34 CM

22 CM

20 W

Parlante Bluetooth 8"

Micrófono con Cable y control / 20W / Luz led / TF card / Aux / USB / Tipo C / FM / Mic in

INCLUYE:



20W



1800 mAh



Luces LED ritmicas



Bluetooth 5.0



Interfaz: BT, FM, SD Y USB



Cod. JV-TTD-8245

EN EL CIRCUITO
4
MESES
DE GARANTÍA

34 CM



20 W

Parlante Bluetooth 8"

Micrófono con Cable y control / 20W / Luz led / TF card / Aux / USB / Tipo C/FM/ Mic in

INCLUYE:



20W



1800 mAh



Luces LED ritmicas



Bluetooth 5.0



Interfaz: BT, FM, SD Y USB



Cod. JV-TTD-8243

22 CM

YANIPPO®

Electronics Technology

EN EL CIRCUITO
4
MESES
DE GARANTÍA

34 CM



20 W

Parlante Bluetooth 8"

Micrófono con Cable y control / 20W / Luz led / TF card / Aux / USB / Tipo C /FM / Mic in

INCLUYE:



20W



1800 mAh



Luces LED ritmicas



Bluetooth 5.0



Interfaz: BT, FM, SD Y USB



Cod. JV-TTD-8251

22 CM



30 CM



20 W

Parlante Bluetooth 8"

Micrófono con Cable y control / 20W / Luz led / TF card / Aux / USB / Tipo C / FM / Mic in

INCLUYE:



20W



1800 mAh



Luces LED ritmicas



Bluetooth 5.0



Interfaz: BT, FM, SD Y USB

Cod. JV-TTD-A8

22 CM



48,1 CM



20 W



VISTA SUPERIOR

INCLUYE:



10*2W



2500 mAh



Luces LED ritmicas



Bluetooth 5.0



Interfaz: BT, FM, SD Y USB

Cod. JV-ZQS6239XW

20,1 CM



10 W

Parlante Bluetooth

- 
Función TWS
- 
1800 mAh
- 
Luces LED ritmicas
- 
Bluetooth 5.0
- 
Interfaz: BT, FM, SD Y USB





Cod. JV-PLUSE6



10 W

21 cm

Parlante Bluetooth

- 
1500 mAh
- 
Luces LED ritmicas
- 
Bluetooth 5.0
- 
Interfaz: BT, FM, SD Y USB

Cod. JV-E-4102



36 cm



10 W

21 cm

Parlante Bluetooth

- 
1500 mAh
- 
Luces LED ritmicas
- 
Bluetooth 5.0
- 
Interfaz: BT, FM, SD Y USB

Cod. JV-E-4102

36 cm



Radio 8 bandas Bluetooth, MP3, Linterna Led

BT, TF, USB, FM

Cod. JV-RX-377BT

5.7cm/2.24inch

14.45cm/5.68inch

8.75cm/3.44inch

10 W



20 cm

Parlante Bluetooth luces Led



Función
TWS



1500
mAh



Luces LED
ritmicas



Bluetooth
5.0



Interfaz:
BT, FM,
SD Y USB

Cod. JV-TG646

7W



21 CM

8 CM

Parlante Bluetooth



Función
TWS



1500
mAh



Luces LED
ritmicas



Bluetooth
5.0



Interfaz:
BT, FM,
SD Y USB

Cod. JV-P5

10 W



25 CM

12 CM

Parlante Bluetooth



10W



2400
mAh



Luces LED
ritmicas



Bluetooth
5.0



Interfaz:
BT, FM,
SD Y USB

Cod. JV-L3204

13 cm



7W

9.5 cm

Parlante mini - Partybox



Función TWS



1500 mAh



Luces LED ritmicas



Bluetooth 5.0



Interfaz: BT, FM, SD Y USB

Cod. JV-ES300

15 cm



5W

Parlante Bluetooth



1200 mAh



Luces LED ritmicas



Bluetooth 5.0



Interfaz: BT, FM, SD Y USB

Cod. JV-S817

5W



14 cm

15 cm

Parlante Bluetooth con micrófono inalámbrico



1200 mAh



Luces LED ritmicas



Bluetooth 5.0



Interfaz: BT, FM, SD Y USB

Cod. JV-CS-0408M

12 cm



5W

10.5 cm

Parlante Bluetooth



800 mAh



Luces LED ritmicas



Bluetooth 5.0



Interfaz: BT, FM, SD Y USB

Cod. JV-MX-SK55

28 cm



5W

13 cm

Parlante Bluetooth



800 mAh



Luces LED ritmicas



Bluetooth 5.0



Interfaz: BT, FM, SD Y USB

Cod. JV-L-3201

11 cm



5W

9.2 cm



Parlante Bluetooth



1200 mAh



Luces LED ritmicas



Bluetooth 5.0



Interfaz: BT, FM, SD Y USB

Cod. JV-TG-351

21 cm



5W

14 cm

Parlante Bluetooth



1200 mAh



Luces LED ritmicas



Bluetooth 5.0



Interfaz: BT, FM, SD Y USB

Cod. JV-ZQS-1461

12 cm



5W

8.5 cm

Parlante Bluetooth



1200 mAh



Luces LED ritmicas



Bluetooth 5.0



Interfaz: BT, FM, SD Y USB

Cod. JV-L010



Parlante **Bluetooth** barra de sonido



Luces LED
ritmicas



Bluetooth
5.0



Interfaz:
BT, FM,
SD Y USB

BT, TF, USB, FM, AUX

Cod. JV-E-3555



Parlante con Luz LED y cargador inalámbrico.

Parlante con Luz LED y cargador inalámbrico.

- 1200 mAh
- Luces LED ritmicas
- Bluetooth 5.0
- Interfaz: BT, FM, SD Y USB

Cod. JV-BT2301

- 1200 mAh
- Luces LED ritmicas
- Bluetooth 5.0
- Interfaz: BT, FM, SD Y USB

Cod. JV-BT-3401



Parlante con Luz LED, cargador inalámbrico y Luz LED de Proyección

- 1200 mAh
- Luces LED ritmicas
- Bluetooth 5.0
- Interfaz: BT, FM, SD Y USB

Cod. JV-G2388A

10 W



Juego de **parlantes**
para computador

con **SUBWOOFER**
color madera 3 pcs



Cod. JV-YST-2202



10W



Juego de **parlantes**
para computador

con **SUBWOOFER**
3 pcs



Cod. JV-A900BT

6W



6 CM

34 CM



1200 mAh



Luces LED ritmicas



Bluetooth 5.0



Interfaz: BT, FM, SD Y USB

Barra de sonido Bluetooth y conector 3.5mm luces Led

Cod. JV-HT2020

YANPO®

Electronics Technology

5W



Parlante Multimedia 2.0

Cod. JV-E-1020

6W



Parlante para Computador

Cod. JV-HT208

6W



Parlante para Computador

Cod. JV-HTA16

6W



**Parlante para
Computador**

Cod. JV-HN88

5W



**Parlante para
Computador**

Cod. JV-HT09

5W



**Parlante para
Computador**

Cod. JV-HT556

5W



**Parlante para
Computador**

Cod. JV-HT414

6W



**Parlante para
Computador**

Cod. JV-FT165



YANPO[®]
ELECTRONIC TECHNOLOGY

UNIONES Y TERMINALES



UNIÓN HDMI

Cod. JV-UHDTV



ANGULO HDMI

MACHO- HEMBRA

Cod. JV-ANGHDTV



UNIÓN HDMI L

Cod. JV-UHDTV-L



CONVERTIDOR HDMI

MACHO- MACHO

Cod. JV-HDTVMM



ADAPTADOR
HDMI A MINI HDMI

CONECTOR CON ENTRADA HDMI A
MINI HDMI.

Cod. JV-HDTV-MINIHDTV



ADAPTADOR
HDMI A MICRO

CONVERTIDOR HDMI A MICRO.

Cod. JV-HDTV-MC



HDMI KEYSTONE

Cod. JV-HDTVKYN



**CODO CONVERTIDOR 3.0
USB**

MACHO-HEMBRA

Cod. JV-COUSB



UNIÓN USB

USO EN PC.
PARA ALARGAR LA EXTENSIÓN DEL
MOUSE O EL TECLADO.

Cod. JV-U-USB



MINIMO 20 UNIDADES

**CONECTOR
RÁPIDO COAXIAL**

Cod. YP-CNR



MINIMO 20 UNIDADES

UNION COAXIAL

Cod. JV-UCOAXIAL



MINIMO 20 UNIDADES

**TERMINAL COAXIAL
ARANDELA**

Cod. JV-TECOAXIAL



MINIMO 20 UNIDADES

**TERMINAL
COAXIAL FINO**

CONECTOR ROSCA RG6.

Cod. JV-RG6-20MM



MINIMO 10 UNIDADES

**CONECTOR F RG6
COMPRESOR POR
UNIDAD (1)**

Cod. JV-COMFRG6



MINIMO 10 UNIDADES

**CABLE DE PODER
SATA**

Cod. JV-POSATA

 **Llegó**



MINIMO 10 UNIDADES

**CABLE SATA
PODER EN Y**

Cod. JV-YPOSATA



-5%

MINIMO 10 UNIDADES

**EXTENSIÓN SATA DE
DATOS**

Cod. JV-EXSATA



**ANTENA TELESCÓPICA
DE 5 SECCIONES. 80 CM
PARA RADIO.**

Cod. YP-AT5-80



**CONVERTIDOR PLÁSTICO
2 JACK RCA - PLUG MONO
6.3MM
POR UNIDAD (1)**

Cod. YP-PG2A1



MINIMO 10 UNIDADES

**CONVERTIDOR 6.3 MONO
JACK RCA METALICO
POR UNIDAD (1)**

Cod. JV-JRCAT06-3



MINIMO 10 UNIDADES

**JACK 3.5 A 6.5 MM DORADO
POR UNIDAD (1)**

Cod. JV-J35X65



MINIMO 10 UNIDADES

**PLUG RCA METÁLICO.
DORADO POR UNIDAD (1)**

Cod. YP-PG124G



MINIMO 10 UNIDADES

**PLUG RCA METÁLICO
SILVER. POR UNIDAD (1)**

Cod. YP-PG130



MINIMO 10 UNIDADES

**JACK RCA METÁLICO
SILVER. POR UNIDAD (1)**

Cod. YP-PG140



MINIMO 10 UNIDADES

**PLUG RCA METÁLICO
POR UNIDAD (1)**

Cod. YP-PG145



CAPUCHONES RJ45
MÍNIMO 100 UND

Cod. JV-CPRJ45



CONECTOR RJ45
MÍNIMO 100 UND

Cod. JV-RJ45



CONECTOR RJ45 CAT 6
MÍNIMO 100 UND

Cod. JV-RJ45-C6



DIVISOR EN T RJ11

Cod. JV-TRJ11



DIVISOR EN T RJ45

Cod. JV-TRJ45



CONECTOR RJ45 CAT6
CON GUIA FTP

Cod. JV-RJ45M-6



CONECTOR RJ45
HEMBRA JACK CAT 6

Cod. JV-JACK6



CONECTOR RJ45
HEMBRA JACK

Cod. JV-RJ45-JACK



CONECTOR RJ11 4 PINES
MÍNIMO 100 UND

Cod. JV-RJ11



UNION RJ11
MÍNIMO 30 UND

USOS EN TELEFONO

Cod. JV-URJ11



UNION RJ45
MÍNIMO 30 UND

Cod. JV-URJ45



UNIÓN VGA
USO EN PC.

Cod. JV-UVGA



¿PARA QUÉ SIRVE?

Si tienes solo un cable de red en una habitación, pero necesitas conectar dos dispositivos (como una computadora y una impresora), este divisor puede ayudarte.

¿CÓMO FUNCIONA?

Este accesorio no divide internet como un router o un switch, sino que simplemente permite enviar dos conexiones a través de un solo cable de red. Para que funcione correctamente, es necesario colocar otro divisor en el otro extremo del cable.

IMPORTANTE: No puedes conectar dos dispositivos al mismo tiempo y esperar que ambos tengan internet sin un equipo adicional como un switch.

DIVISOR RJ45 FINO

Cod. JV-SPRJ

REQUIERE PONCHADORA ESPECIAL PARA
PASS THROUGH



-10%

CONECTOR RJ45 PASS
THROUGH
CAT 5 BOLSA 100PCS

Cod. JV-THRJ45-5

-28%

CONECTOR RJ45 PASS
THROUGH
CAT 6 BOLSA 100PCS

Cod. JV-THRJ45-6





PRECIO POR
4 CONECTORES



CONECTOR PARA PANEL SOLAR
SENCILLO 1000V 30A

Cod. JV-MC4



CREMA DISIPADORA EN
JERINGA DELGADA

Cod. JV-HY100



CREMA DISIPADORA JERINGA
20 GRAMOS.

Cod. JV-HY510



CREMA DISIPADORA EN TARRO

Cod. JV-HY510-TA



YANPO[®]
ELECTRONIC TECHNOLOGY

CABLES Y EXTENSIONES



(CABLES PARA AUDIO, HDMI, IMPRESORAS, UTP, ETC...)



CABLE VGA MACHO-MACHO



- **FILTROS EN LAS DOS PUNTAS.**
- **ENCAUCHETADO.**

**CABLE VGA
MACHO MACHO 1-5M**

Cod. JV-CAVGA1-5M

**CABLE VGA
MACHO MACHO 3M**

Cod. JV-CAVGA3M

**CABLE VGA
MACHO MACHO 5M**

Cod. JV-CAVGA5M

**CABLE VGA
MACHO MACHO 7M**

Cod. JV-CAVGA-7M

**CABLE VGA
MACHO MACHO 10M**

Cod. JV-CAVGA-10M

CABLE VGA + FINO

MACHO-MACHO



Más grueso para clientes más exigentes.

Encauchetado

Mayor calibre

Ranurado

30 v

CABLE VGA MACHO MACHO
1.5MT FINA

Cod. JV-FVGA1-5M

CABLE VGA MACHO MACHO
3 MT FINA

Cod. JV-FVGA3M

CABLE VGA MACHO MACHO
5M FINA

Cod. JV-FVGA5M

CABLE VGA MACHO
MACHO 10M FINA

Cod. JV-FVGA10M

CABLE VGA MACHO
MACHO 15M FINA

Cod. JV-FVGA15M

BAJÓ

CABLE HDMI MALLADO

- MUY BUENA CALIDAD
- VERSION 1.4 – 3D
- SOPORTA 3D

- Vienen con filtros en las dos puntas disponibles en color negro con conectores de color gris.
- Vienen en bolsa de alta resistencia.



MACHO - MACHO



CABLE HDMI 1.5MT
Cod. JV-HDTV-1-5M



CABLE HDMI 3MT
Cod. JV-HDTV-3M

CABLE HDMI 5MT
Cod. JV-HDTV-5M



CABLE HDMI 7MT
Cod. JV-HDTV-7M

CABLE HDMI 10MT
Cod. JV-HDTV-10M



CABLE HDMI 15MT
Cod. JV-HDTV-15M



CABLE HDMI 20MT
Cod. JV-HDTV-20M

CABLE HDMI 25MT
Cod. JV-HDTV-25M

HDMI ENCAUCHETADO

MACHO - MACHO

-SOPORTA 3D

-10%

CABLE HDMI 1-5M
ENCAUCHETADO

Cod. JV-HDTVEC-1-5M

CABLE HDMI 3M
ENCAUCHETADO

Cod. JV-HDTVEC-3M

-8%

CABLE HDMI
5MT ENCAUCHETADO

Cod. JV-HDTVEC-5M

-10%

CABLE HDMI
7MT ENCAUCHETADO

Cod. JV-HDTVEC-7M

-7%

CABLE HDMI
10MT ENCAUCHETADO

Cod. JV-HDTVEC-10M

CABLE HDMI
15MT ENCAUCHETADO

Cod. JV-HDTVEC-15M

-9%

CABLE HDMI
20MT ENCAUCHETADO

Cod. JV-HDTVEC-20M

CABLE HDMI
25MT ENCAUCHETADO

Cod. JV-HDTVEC-25M

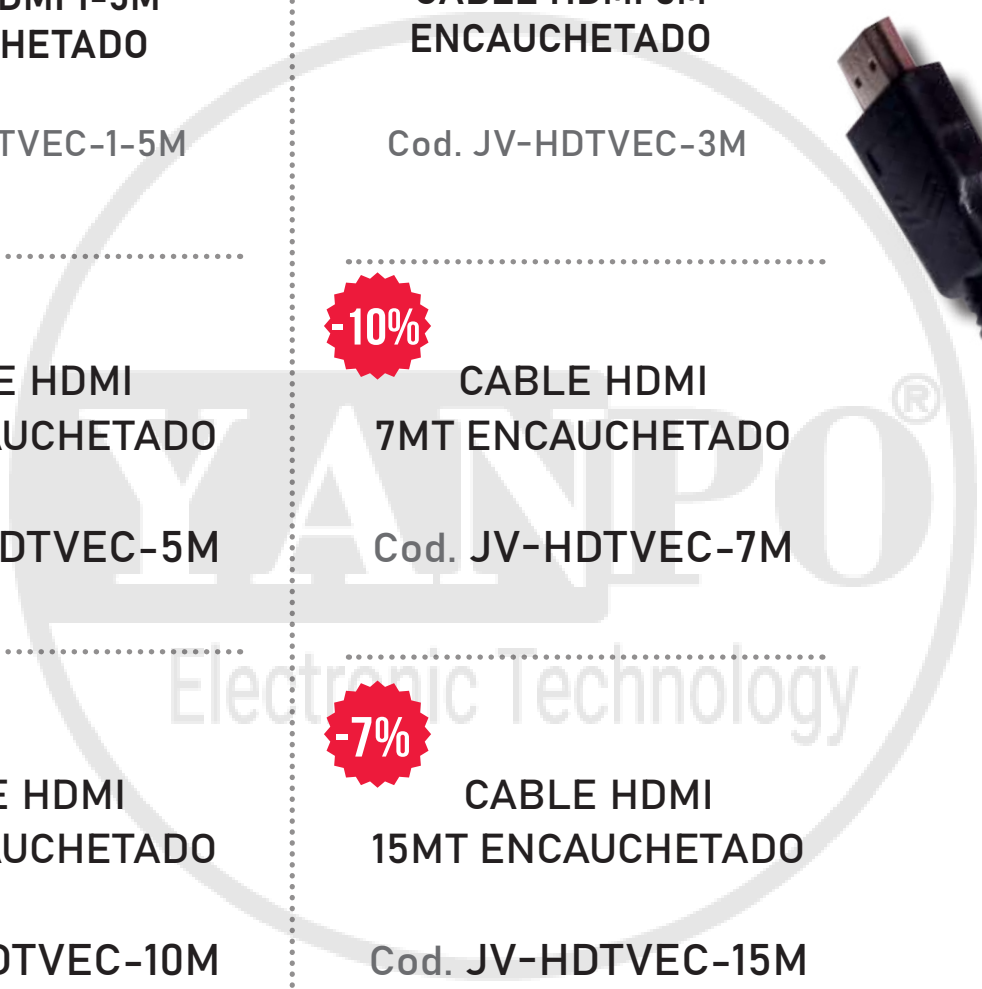

CABLE HDMI PLANO



CABLE HDMI PLANO
1.5MT

Cod. JV-HDTVPL-1-5M

-20%

CABLE HDMI PLANO
3M

Cod. JV-HDTVPL-3M

CABLE HDMI PLANO
5M

Cod. JV-HDTVPL-5M

CABLE HDMI PLANO
7MT

Cod. JV-HDTVPL-7M



-25%

CABLE HDMI 
PLANO 15M

Cod. JV-HDTVPL-15M

-24%

CABLE HDMI
PLANO 20M

Cod. JV-HDTVPL-20M



CABLE HDMI PLANO
COLOR BLANCO 15M

Cod. JV-HDTVPLWH-15M

CABLE HDMI 4K

CALIDAD EXTREMA



- ✓ Calidad premium para dispositivos de última generación.
- ✓ Imagen más nítida y colores más vivos en TVs 4K y monitores de gaming.
- ✓ Conexión estable y sin latencia para juegos, streaming y videoconferencias.

El cable perfecto para maximizar la calidad de tus dispositivos más modernos!

Especificaciones:

Resolución Ultra HD: Soporta 4K @ 60Hz, 2K, 1080p y 3D.

Conectores de alta calidad: Una mejor conductividad y durabilidad.

Cable reforzado: Diámetro exterior de 8mm con chaqueta de PVC resistente.

Blindaje avanzado: Reduce interferencias y mejora la estabilidad de la señal.



-13%

CABLE HDMI 4K 1.5MT

Cod. JV-HDTV4K-1-5M

-25%

CABLE HDMI 4K 3MT

Cod. JV-HDTV4K-3M

-22%

CABLE HDMI 4K 5MT

Cod. JV-HDTV4K-5M

-11%

CABLE HDMI 4K 10MT

Cod. JV-HDTV4K-10M

CABLE HDMI 4K 15MT

Cod. JV-HDTV4K-15M



CABLE HDMI 8K



Este cable HDMI de alta gama está diseñado para ofrecer una transmisión de audio y video de ultra alta definición, siendo ideal para los entusiastas de la tecnología que buscan la mejor calidad en sus dispositivos modernos.

Características principales:

- ✓ Resolución hasta 8K @ 120Hz (compatible con 4K @ 144Hz/120Hz).
- ✓ HDMI 2.1 – 48 Gbps para máxima velocidad y calidad de imagen.
- ✓ Conectores chapados en oro y cobre sin oxígeno 99.996% para mejor conductividad.
- ✓ Triple blindaje para reducir interferencias.
- ✓ Diseño flexible con capacidad de 90° de flexión.



2.1V 8K HDMI BLACK
CABLE 1.5M

Cod. **JV-HDTV8K1-5M**

2.1V 8K HDMI BLACK
CABLE 3M

Cod. **JV-HDTV8K-3M**

2.1V 8K HDMI BLACK
CABLE 5M

Cod. **JV-HDTV8K-5M**

2.1V 8K HDMI BLACK
CABLE 10M

Cod. **JV-HDTV8K-10M**

CABLE MINI DISPLAYPORT

-14%



**CABLE MINI DISPLAY
PORT A HDMI 1.8M**

Cod. JV-MDPH1-8M

CABLE DISPLAYPORT

-16%



**CABLE DISPLAYPORT
A DISPLAYPORT
MACHO-MACHO 1.8M**

Cod. JV-DP1-8M



**CABLE DISPLAYPORT
A DISPLAYPORT
MACHO-MACHO 3M**

Cod. JV-DP3M

CABLE HDMI FIBRA OPTICA



CALIDAD DE IMAGEN SUPERIOR: El cable HDMI de fibra óptica S1PU 4K 60Hz 18Gbps garantiza la transmisión de audio y video de alta definición, admitiendo resoluciones de hasta 4Kx2K y frecuencias de actualización de 60Hz para una experiencia de visualización inmersiva, ideal para usuarios con televisores y consolas de juegos de alta gama.

CONSTRUCCIÓN DURADERA: El cable cuenta con un material de aleación de zinc, conductores chapados y una cubierta de PVC, lo que garantiza durabilidad y resistencia al desgaste, lo que lo hace adecuado para uso frecuente y aplicaciones de trabajo pesado.

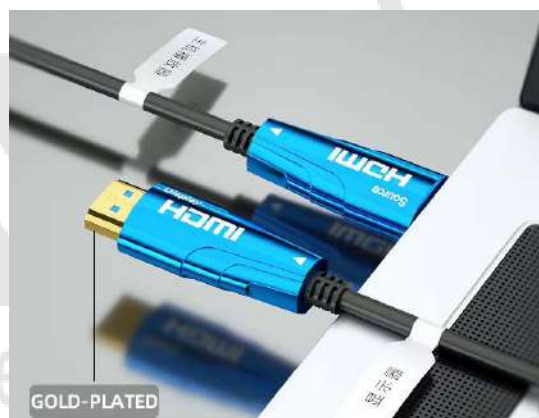

CABLE HDMI FIBRA OPTICA 30M

Cod JV-FBHDMI-30M

.....

CABLE HDMI FIBRA OPTICA 50M

Cod. JV-FBHDMI-50M

CABLE HDMI MINI

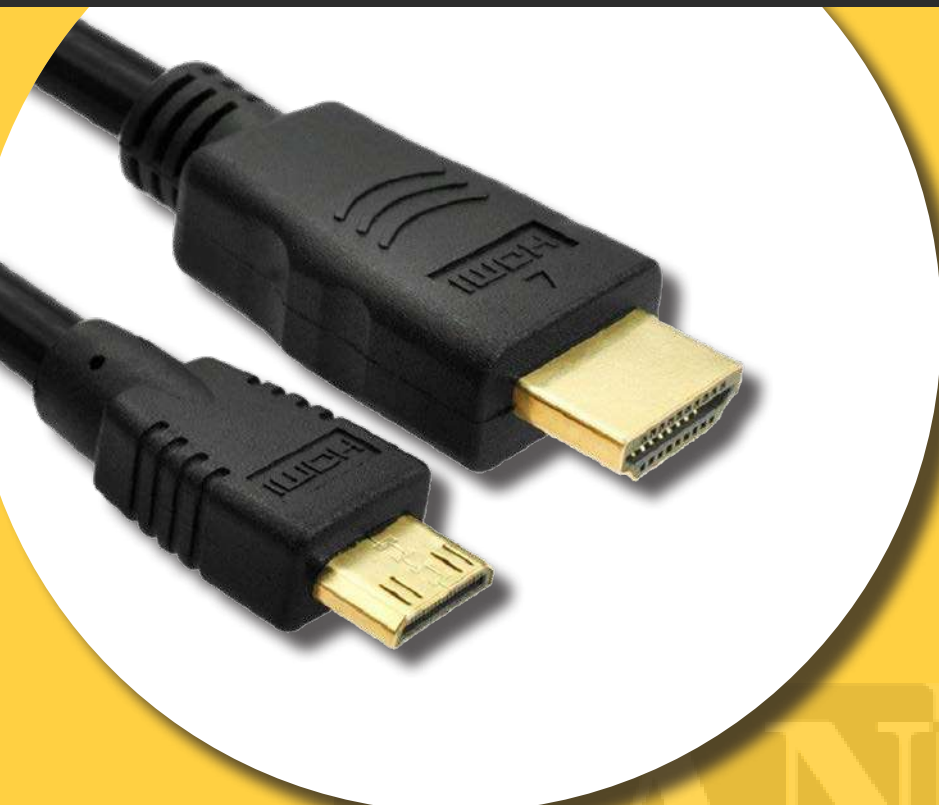

CABLE HDMI A MINI HDMI

Cod. JV-HDTV-MINI

MINI HDMI CABLE 3M

Cod. JV-HDTV3M-MINI

MINI HDMI CABLE 5M

Cod. JV-HDTV5M-MINI

CABLE HDMI MICRO



CABLE MICRO HDMI 1.5M

Cod. JV-HDTV-MICRO

MICRO HDMI CABLE 3M

Cod. JV-HDTV3M-MICRO

MICRO HDMI CABLE 5M

Cod. JV-HDTV5M-MICRO

CABLES TELEFÓNICOS



CABLE ESPIRAL
TELÉFONO 2MT
Blanco

Cod. JV-WES2M



CABLE ESPIRAL
TELÉFONO 3MT
Blanco

Cod. JV-WES3M



CABLE ESPIRAL
TELÉFONO 2MT
Negro

Cod. JV-BES2M



CABLE ESPIRAL
TELÉFÓNICO 3 MT
Negro

Cod. JV-BES3M



CABLE TELEFÓNICO
PLANO 2 MT
Blanco

Cod. JV-WCT2M



CABLE TELEFÓNICO
PLANO 3 MT
Blanco

Cod. JV-WCT3M



**CABLE TELEFÓNICO
PLANO 5 MT
BLANCO**

Cod. JV-WCT5M



**CABLE TELEFÓNICO
PLANO 7 MT
BLANCO**

Cod. JV-WCT7M



**CABLE TELEFÓNICO
PLANO 3 MT
NEGRO**

Cod. JV-BCT3M



**CABLE
TELEFÓNICO PLANO
4 MT
NEGRO**

Cod. JV-BCT4M



**CABLE
TELEFÓNICO
PLANO 5 MT
NEGRO**

Cod. JV-BCT5M



**CABLE TELEFÓNICO
PLANO 7 MT
NEGRO**

Cod. JV-BCT7M

CABLE DE AUDIO 1X1 ESTEREO



CABLE AUDIO 1X1
ESTEREO 3.5 MM - 1.5M

Cod. JV-1X1-1-5M

CABLE AUDIO 1X1
ESTEREO 3.5 MM - 3M

Cod. JV-1X1-3M

CABLE AUDIO 1X1
ESTEREO 3.5 MM - 5M

Cod. JV-1X1-5M

CABLE DE AUDIO 1X1 ESTEREO OXIGENADA



CABLE 1X1 ESTÉREO
OXIGENADA 1MT

Cod. JV-OX-1X1-1M



CABLE 1X1 ESTÉREO
OXIGENADA 3MT

Cod. JV-OX-1X1-3M

EXTENSIÓN ESTÉREO 3.5 MM



EXTENSIÓN MACHO
HEMBRA ESTEREO
3.5MM 1-5M

Cod. JV-X35-1-5M

EXTENSIÓN
MACHO HEMBRA
ESTEREO 3.5MM 3M

Cod. JV-X35-3M

EXTENSIÓN
MACHO HEMBRA
ESTEREO 3.5MM 5M

Cod. JV-X35-5M

EXTENSIÓN
MACHO HEMBRA
ESTEREO 3.5MM 7M

Cod. JV-X35-7M

EXTENSIÓN
MACHO HEMBRA
ESTEREO 3.5MM 10M

Cod. JV-X35-10M

CABLE DE AUDIO 2X1 ESTEREO



**CABLE AUDIO
2X1 ESTEREO 1.5M**

Cod. JV-2X1-1-5M



**CABLE AUDIO 2X1
ESTEREO 3M**

Cod. JV-2X1-3M



**CABLE AUDIO
2X1 ESTÉREO 5MT**

Cod. JV-2X1-5M



**CABLE 2X1 ESTÉREO 3MT
OXIGENADO**

Cod. JV-OX-2X1-3M



**CABLE 2 RCA X 1 STEREO
4.5MT TRANSP**

Cod. JV-OX2X1-4-5M



**CABLE 2X1 ESTÉREO 7MT
OXIGENADO**

Cod. JV-OX-2X1-7M

✓ Llegó



**CABLE 2X2 RCA M-M
NEGRA**

Cod. JV-2X2-1-5M

-8%



**CABLE 3.5 ESTEREO A 3
RCA MACHO 1-5M**

Cod. JV-M3RCAX35



**CABLE AUDIO Y VIDEO
3X3 RCA 1-5M**

Cod. JV-3X3-1-5M



**CABLE AUDIO Y VIDEO
3X3 RCA 3M**

Cod. JV-3X3-3M

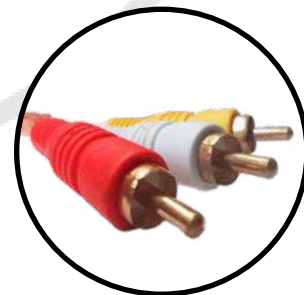

**CABLE AUDIO 3X3
ESTEREO 3.5MM 1-5M
OXIGENADO**

Cod. JV-3X3CR1-5M

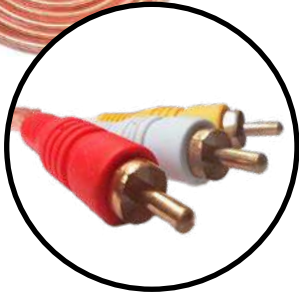
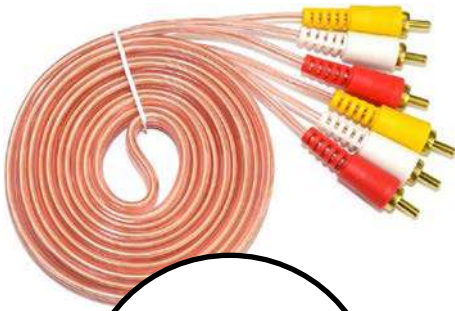

**CABLE AUDIO 3X3
ESTEREO 3.5MM 3M
OXIGENADO**

Cod. JV-3X3CR3M

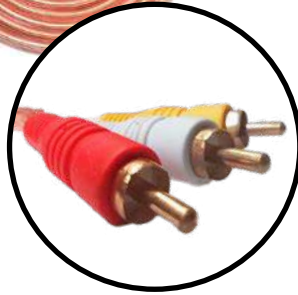
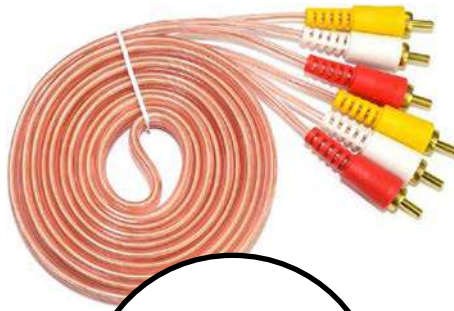

**CABLE AUDIO 3X3
ESTEREO 3.5MM 5M
OXIGENADO**

Cod. JV-3X3CR5M

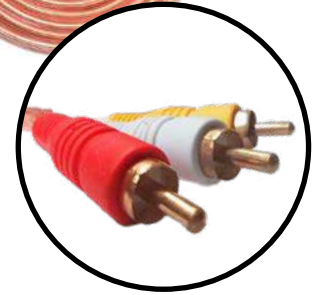
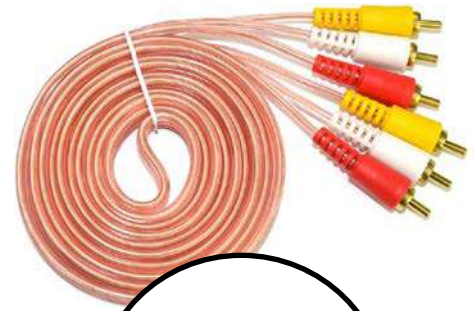

**CABLE AUDIO 3X3
ESTEREO 3.5MM 7M
OXIGENADO**

Cod. JV-3X3CR7M

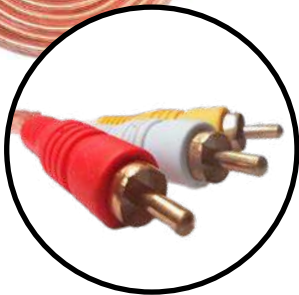
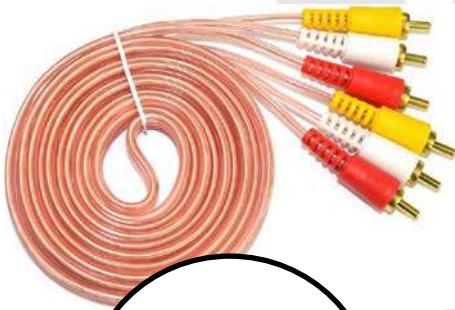

**CABLE AUDIO 3X3
ESTEREO 3.5MM 10M
OXIGENADO**

Cod. JV-3X3CR10M

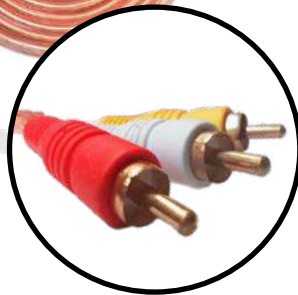
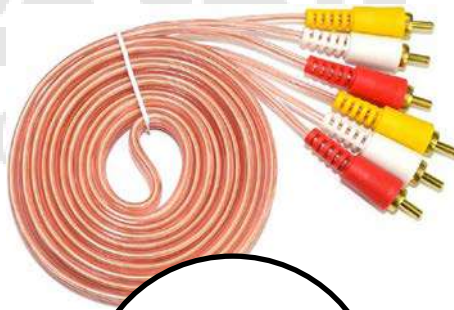

**CABLE AUDIO 3X3
ESTEREO 3.5MM 15M
OXIGENADO**

Cod. JV-3X3CR15M

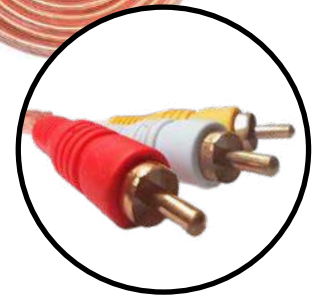
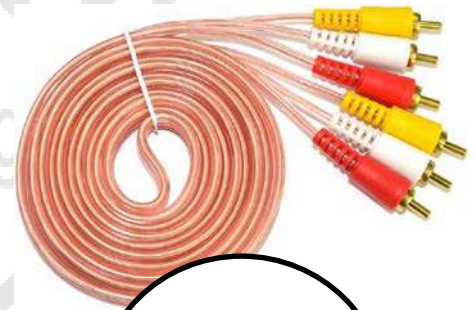

**CABLE AUDIO 3X3
ESTEREO 3.5MM 20M
OXIGENADO**

Cod. JV-3X3CR20M



1 RCA HEMBRA
A 2 RCA MACHO

Cod. JV-FRCATOM2RCA



1 RCA MACHO A
2 RCA HEMBRA

Cod. JV-MRCATOF2RCA

YANPO®

Technology



CABLE DE AUDIO 2RCA
X 3.5MM ESTEREO
OXIGENADO

Cod. JV-2X1CR1-5M



CABLES PARA AUDIO



**CABLE PLUG 6.35MM A XLR
HEMBRA 1.8 M**

Cod. JV-XLR635F-1-8M

**CABLE PLUG 6.35MM A XLR
HEMBRA 5M**

Cod. JV-XLR635F-5M

**CABLE PLUG 6.35MM A XLR
HEMBRA 3M**

Cod. JV-XLR635F-3M

**CABLE PLUG 6.35MM A XLR
HEMBRA 7M**

Cod. JV-XLR635F-7M

**CABLE PLUG 6.35MM A XLR
HEMBRA 10M**

Cod. JV-XLR635F-10M

CABLES PARA AUDIO



Ideal para escenarios y aplicaciones de audio profesional.

- * Sonido puro y estable gracias a su núcleo de latón sin oxígeno de 20 AWG.
- * Reducción de interferencias con estructura de protección multicapa que elimina ruido y zumbidos.
- * Construcción duradera con carcasa de aleación de aluminio y conector blindado de alta resistencia.
- * Conexión segura con diseño de bloqueo y banda de agarre de 360°.
- * Máximo rendimiento con cables de impedancia balanceada que minimizan el ruido EM y RF.
- * ¡Calidad garantizada para tu equipo de audio!

**CABLE PLUG 6.35MM A
XLR MACHO 1.8 M**

Cod. JV-XLR635M-1-8M

.....

**CABLE PLUG 6.35MM
A XLR MACHO 3M**

Cod. JV-XLR635M-3M

.....

**CABLE PLUG 6.35MM
A XLR MACHO 5M**

Cod. JV-XLR635M-5M

.....

**CABLE PLUG 6.35MM
A XLR MACHO 7M**

Cod. JV-XLR635M-7M

.....

**CABLE PLUG 6.35MM
A XLR MACHO 10M**

Cod. JV-XLR635M-10M



**CABLE XLR MACHO A HEMBRA
1 METRO**

Cod. JV-XLRMF-1M



**CABLE XLR MACHO A HEMBRA
1.8 METROS**

Cod. JV-XLRMF-1-8M

**CABLE XLR MACHO A HEMBRA
3 METROS**

Cod. JV-XLRMF-3M

**CABLE XLR MACHO A HEMBRA
5 METROS**

Cod. JV-XLRMF-5M

**CABLE XLR MACHO A HEMBRA
7 METROS**

Cod. JV-XLRMF-7M

**CABLE XLR MACHO A
HEMBRA 10 METROS**

Cod. JV-XLRMF-10M

**CABLE XLR MACHO A HEMBRA
15 METROS**

Cod. JV-XLRMF-15M



**CABLE 3.5 ST A XLR
HEMBRA 5M**

Cod. JV-XLR35F-5M



NIPO[®]

Technology



Compatible Devices



**CABLE 3.5 STEREO A
1/4 STEREO 1.8M**

Cod. JV-635X35-1-8M

**CABLE 3.5 STEREO A
1/4 STEREO 3M**

Cod. JV-635X35-3M

**CABLE 3.5 STEREO A
1/4 STEREO 5M**

Cod. JV-635X35-5M

✓ Llegó



**CABLE 3.5MM ST A XLR
HEMBRA 1.5M**

Cod. JV-XLR35M-1-5M



**CABLE 1/4 MONO
MACHO-MACHO 1.8M**

Cod. JV-635MM-1-8M



**CABLE 1/4 MONO
MACHO-MACHO 3M**

Cod. JV-635MM-3M

YANIPPO®



**CABLE 1/4 MONO
MACHO-MACHO 5M**

Cod. JV-635MM-5M



**DRIVER 1.75" (44.4MM)
TITANIUM 40W 8 OHM**

Cod. JV-CD-44



**DRIVER 1.35" (34.4MM)
TITANIUM 30W 8 OHM**

Cod. JV-CD-34



CONECTOR SPEAKON

Cod. JV-PGCA



DRIVER 1.1" (28MM)
TITANIUM 30W 8 OHM

Cod. JV-CD-25



DIAFRAGMA PARA
DRIVER 1.1" (28MM)

Cod. JV-TU25



DIAFRAGMA PARA
DRIVER 1.35" (34.3MM)

Cod. JV-TU34



DIAFRAGMA PARA
DRIVER 1.75" (44.4MM)

Cod. JV-TU44



DIAFRAGMA PARA
DRIVER 2" (51MM)

Cod. JV-TU51

CABLE UTP CATEGORIA 7



**1.5M CAT.7 PATCH CORD
SFTP FULL COPPER**

Cod. JV-CAT7-1-5M

**3M CAT.7 PATCH CORD
SFTP FULL COPPER**

Cod. JV-CAT7-3M

**5M CAT.7 PATCH CORD
SFTP FULL COPPER**

Cod. JV-CAT7-5M

**8M CAT.7 PATCH CORD
SFTP FULL COPPER**

Cod. JV-CAT7-8M

**10M CAT.7 PATCH CORD
SFTP FULL COPPER**

Cod. JV-CAT7-10M

CABLE UTP CATEGORIA 6E



**CABLE DE RED
CAT6E 0.5M**

Cod. JV-CAT6-05M

**CABLE DE RED
CAT6E 1M**

Cod. JV-CAT6-1M

**CABLE DE RED
CAT6E 2M**

Cod. JV-CAT6-2M

**CABLE DE RED
CAT6E 5M**

Cod. JV-CAT6-5M

**CABLE DE RED
CAT6E 8M**

Cod. JV-CAT6-8M

**CABLE DE RED
CAT6E 10M**

Cod. JV-CAT6-10M

**CABLE DE RED
CAT6E 15M**

Cod. JV-CAT6-15M

**CABLE DE RED
CAT6E 20M**

Cod. JV-CAT6-20M

**CABLE DE RED
CAT6E 30M**

Cod. JV-CAT6-30M

PATCH CORD



CABLE UTP CATEGORIA 5E



Llegó

**CABLE DE RED
CAT5E 50 CM**

Cod. JV-CAT5-05M

**CABLE DE RED
CAT5E 1M**

Cod. JV-CAT5-1M



Llegó

**CABLE DE RED
CAT5E 2M**

Cod. JV-CAT5-2M

**CABLE DE RED
CAT5E 3M**

Cod. JV-CAT5-3M

**CABLE DE RED
CAT5E 5M**

Cod. JV-CAT5-5M

**CABLE DE RED
CAT5E 10M**

Cod. JV-CAT5-10M

**CABLE DE RED
CAT5E 15M**

Cod. JV-CAT5-15M

**CABLE DE RED
CAT5E 20M**

Cod. JV-CAT5-20M

**CABLE DE RED
CAT5E 30M**

Cod. JV-CAT5-30M

CATEGORIA 5



INTERIOR

**CABLE DE RED
CAT5E 305M**

Cod. JV-CAT5-305M



EXTERIOR

**UTP EXTERIOR CABLE
CAT.5E 0.48CCA 305M**

Cod. JV-OUTCAT5-305m

CATEGORIA 6



INTERIOR

**CABLE DE RED
CAT6E 305M**

Cod. JV-CAT6-305M



EXTERIOR

**UTP EXTERIOR CABLE
CAT.6E 0.57CCA 305M**

Cod. JV-OUTCAT6-300M



FACE PLATE 2X4

Cod. JV-FP2X4



CAJA PARA RJ45
1 PUERTO + 1 KEYSTONE

CATEGORÍA 5

Cod. JV-CJ45KYN5



CAJA PARA RJ45
2 PUERTOS+2*KEYSTONE

CATEGORÍA 5

Cod. JV-CJ45X2KYN5

CABLES USB NEGRAS MACHO - MACHO



**CABLE USB
MACHO - MACHO 60CM**

Cod. JV-MTOM-N60

**CABLE USB
MACHO - MACHO 1.5MT**

Cod. JV-MTOM-N15

**CABLE USB
MACHO - MACHO 3MT**

Cod. JV-MTOM-N3

**CABLE USB
MACHO - MACHO 5MT**

Cod. JV-MTOM-N5

**CABLE USB
MACHO - MACHO 7MT**

Cod. JV-MTOM-N7

CABLE USB BLINDADAS MACHO - MACHO



CABLE USB
MACHO MACHO 30CM

Cod. JV-MTOM-30



CABLE USB
MACHO MACHO 1-5M

Cod. JV-MTOM1-5M



CABLE USB
MACHO MACHO 3M

Cod. JV-MTOM-3M

CABLES USB V 3.0 MACHO - MACHO



CABLE USB
MACHO MACHO 1,5MT

VELOCIDAD 3.0

Cod. JV-MTOM1-5M3V

CABLE USB
MACHO MACHO 3MT

VELOCIDAD 3.0

Cod. JV-MTOM3M3V



CABLE USB
MACHO MACHO 5MT

VELOCIDAD 3.0

Cod. JV-MTOM5M3V

EXTENSIONES USB NEGRAS MACHO - HEMBRA



-10%

EXTENSIÓN USB 1-5MT
NEGRA

JV-USBEC1-5M

-6%

EXTENSIÓN USB 3MT
NEGRA

JV-USBEC-3M



EXTENSIÓN USB 5MT
NEGRA

JV-USBEC-5M

EXTENSIÓN USB 7MT
NEGRA

JV-USBEC-7M

EXTENSIONES USB BLINDADAS MACHO - HEMBRA



EXTENSIÓN USB
BLINDADA 30CM

Cod. JV-USBM-USBH

-9%

EXTENSIÓN USB
BLINDADA 1-5M

Cod. JV-XUSB-1-5M

-6%

EXTENSIÓN USB
BLINDADA 3M

Cod. JV-XUSB-3M

✓ Llegó

BAJÓ

EXTENSIÓN USB
BLINDADA 5M

Cod. JV-XUSB-5M



EXTENSIÓN USB
BLINDADA 7M

Cod. JV-XUSB-7M

EXTENSIÓN USB
BLINDADA 10M

Cod. JV-XUSB-10M

EXTENSIONES USB V 3.0 MACHO - HEMBRA



EXTENSIÓN USB 1.5MT

VELOCIDAD 3.0

Cod. JV-XUSB1-5M3V

EXTENSION USB 3MT

VELOCIDAD 3.0

Cod. JV-XUSB3M3V

EXTENSIÓN USB 5MT

VELOCIDAD 3.0

Cod. JV-XUSB5M3V

¿SABIAS QUE?

USB 3.0 ES DIEZ VECES MAS RAPIDA QUE USB 2.0, REDUCIENDO SIGNIFICATIVAMENTE EL TIEMPO REQUERIDO PARA LA TRANSMISIÓN DE DATOS, EL CONSUMO DE ENERGÍA Y ES COMPATIBLE CON USB 2.0.

EXTENSIÓN USB ACTIVA



Este cable de extensión alimentado por USB, puede usarse para aumentar la longitud de un cable de dispositivo sin la preocupación de perder señal o tener problemas potenciales de rendimiento.

EXTENSIÓN USB CON IC
5 METROS

Cod. JV-ACUSB-5M

EXTENSIÓN USB CON IC
10 METROS

Cod. JV-ACUSB-10M

EXTENSIÓN USB CON IC
15 METROS

Cod. JV-ACUSB-15M

EXTENSIÓN USB CON IC
20 METROS

Cod. JV-ACUSB-20M

EXTENSIÓN USB 3,0 ACTIVO, REPETIDOR MACHO A HEMBRA



Este cable de extensión USB 3,0 es capaz de cargar y transferir datos, una velocidad de transferencia ATA de hasta 5Gbps - 10 veces más rápido que USB 2,0 (480 Mbps). Un PUERTO DE 5V en el lateral para la carga de los dispositivos de La USB-C. También es compatible con USB 2,0, 1,1 y 1,0.

**EXTENSION USB 3.0
10 METROS**

Cod. JV-USB30-10M

**EXTENSION USB 3.0
15 METROS**

Cod. JV-USB30-15M

**EXTENSION USB 3.0
20 METROS**

Cod. JV-USB30-20M

CABLE ÓPTICO NEGRO



Sonido digital de alta calidad mediante fibra óptica, sin interferencias en la señal. El cable digital de fibra óptica, ofrece un sonido limpio y real, sin distorsiones ni interferencias de señal.

El delgado grosor de este cable SPDIF resulta perfecto para instalaciones en espacios estrechos. Incluye una lente pulida que garantiza la captación fiable de la señal y una alta calidad de sonido digital.



CABLE ÓPTICO 1.5MT
NEGRO ECONÓMICO

Cod. JV-OPB1-5M

CABLE ÓPTICO 3MT
NEGRO ECONÓMICO

Cod. JV-OPB3M

CABLE ÓPTICO 5MT
NEGRO ECONÓMICO

Cod. JV-OPB5M

CABLE ÓPTICO MÁS FINO



El cable de audio digital le brinda la señal más limpia posible, incluso a niveles de volumen extremos. Los cables ópticos transfieren la señal usando luz; por lo tanto, eliminando completamente cualquier posibilidad de interferencia de RFI, EMI o bucle a tierra.



CABLE ÓPTICO 1.5MT

Cod. JV-OP1-5M

CABLE ÓPTICO 3MT

Cod. JV-OP3M

CABLE ÓPTICO 5MT

Cod. JV-OP5M

CABLE USB A MINI USB 5 PINES



CABLE USB A
MINI USB 5 PINES
1.5 METROS

Cod. JV-USB-MINI

CABLE USB A MINI
USB 5 PINES NEGRO
3 METROS

Cod. JV-USBMINI-3M



CABLE USB 5 PINES
BLINDADO 1.5 METROS

Cod. JV-5P1-5M

CABLE USB 5 PINES
BLINDADO 3 METROS

Cod. JV-5P3M



CABLE USB
HEMBRA A CABLE
5 PINES 15CM

Cod. JV-MUTOHU

CABLE USB HEMBRA A
CABLE
5 PINES 30CM

Cod. JV-FUSBT05P

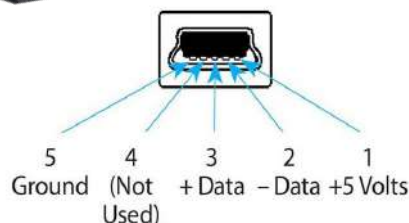

CABLES DE IMPRESORA NEGRAS



-12%

**CABLE USB
IMPRESORA 1.5MT**

Cod. JV-IMPRES-1-5M



-10%

Llegó

**CABLE USB
IMPRESORA 5MT**

Cod. JV-IMPRES5M

**CABLE USB
IMPRESORA 7MT**

Cod. JV-IMPRES-7M

CABLES DE IMPRESORA BLINDADAS



-6%

**CABLE IMPRESORA
USB BLINDADO 1.5 MT**

Cod. JV-BL-1-5M



-8%

Llegó

**CABLE IMPRESORA
USB BLINDADO 3 MT**

Cod. JV-BL-3M

**CABLE IMPRESORA
USB BLINDADO 5 MT**

Cod. JV-BL-5M

**CABLE IMPRESORA
USB BLINDADO 7 MT**

Cod. JV-BL-7M

Llegó

**CABLE IMPRESORA
USB BLINDADO 10 MT**

Cod. JV-BL-10M

CABLES DE IMPRESORA V 3.0



VELOCIDAD 3.0

CABLE DE IMPRESORA 3 MT

Cod. JV-BL3M3V

\$9.900

¿Para qué dispositivos sirve?

Este cable es ideal para conectar:

- ✓ Impresoras modernas con puerto USB 3.0.
- ✓ Escáneres que requieren alta velocidad de transmisión.

CABLES DE IMPRESORA TIPO C



CABLE DE IMPRESORA TIPO C 1.5 MT

Cod. JV-TCIMPRE1-5M

.....
CABLE DE IMPRESORA TIPO C 3 MT

Cod. JV-TCIMPRE-3M

CABLES DE PODER



**CABLE GRABADORA
SILVER 1.5 METROS - CAL.
2X20
ENCAUCHETADO**

Cod. JV-SILVER



**CABLE GRABADORA
SILVER 3 METROS -
CAL. 2X20
ENCAUCHETADO**

Cod. JV-SILVER3



**CABLE GRABADORA
SILVER 5 METROS - CAL.
2X20
ENCAUCHETADO**

Cod. JV-SILVER5M



CABLE DE PODER 1.5MT

Cod. JV-CAPODER



CABLE DE PODER 3MT

Cod. JV-CAPODER3M



CABLE DE PODER 5MT

Cod. JV-CAPODER5M

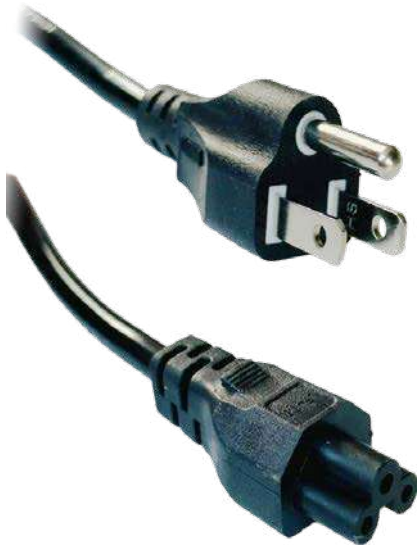

**CABLE DE PODER REDONDO
TREBOL 1.5 MT**

Cod. JV-CATREBOL

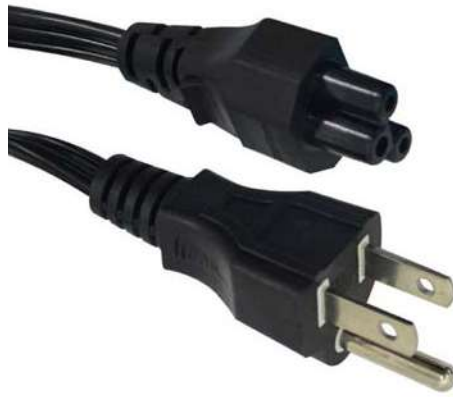

**CABLE PODER TREBOL
PLANO 1.5 MT**

Cod. JV-CATREBOLPL



**CABLE DE PODER
14AWG
100% COBRE 1.8M**

Cod. JV-CA14AWG1-8M



**CABLE DE PODER
14AWG
100% COBRE 3M**

Cod. JV-CA14AWG3M



**CABLE DE PODER
14AWG
100% COBRE 5M**

Cod. JV-CA14AWG5M



**CABLE DE PODER
16AWG
100% COBRE 1.8M**

Cod. JV-CA16AWG1-8M



✓ Llegó



**CABLE DE PODER
16AWG
100% COBRE 3M**

Cod. JV-CA16AWG3M



**CABLE DE PODER 16AWG
100% COBRE 5M**

Cod. JV-CA16AWG5M



✓ Llegó



**CABLE DE PODER 18AWG
100% COBRE 1.8M**

Cod. JV-EX18AWG1-8M



**CABLE DE PODER
18AWG
100% COBRE 3M**

Cod. JV-EX18AWG3M



**CABLE DE PODER
16AWG
100% COBRE 3M**

Cod. JV-EX16AWG3M



**CABLE DE PODER
16AWG
100% COBRE 5M**

Cod. JV-EX16AWG5M

CABLES PARA VARIOS USOS



CABLE OTG V8
(TIPO SAMSUNG) 10CM

Cod. JV-OTG-10CM



CABLE OTG V8 30CM

Cod. JV-OTG-30CM-B



CABLE OTG TIPO C

Cod. JV-CCTIPO



EXTENSION TIPO C
MACHO HEMBRA 1M

Cod. JV-XCTOC-1M



EXTENSION TIPO C
MACHO HEMBRA 1.5M

Cod. JV-XCTOC-1-5M



CONECTOR DE AUDIO ESTÉREO
DE 3,5 MM AURICULAR
AURICULAR ADAPTADOR
DIVISOR U DE 2 VÍAS

Cod. JV-YSTM



**DIVISOR AUDÍFONOS
3.5MM**

Cod. JV-35X235



**CABLE CONVERTIDOR
2 PLUG STEREO 3.5 A 1
JACK TRIO 3.5**

Cod. JV-AUXG2



**EXTENSIÓN
TRI ESTEREO 1 METRO**

Cod. JV-XTRI1M



**CABLE DE AUDIO
3.5MM A 2.5MM
Largo: 20 Cmt.**

Cod. JV-35X25



**DIVISOR DE AUDIFONO Y
MICROFONO**

Cod. JV-TR-STM



**DIVISOR DE AUDIFONO Y
MICROFONO**

Cod. JV-TR32



**EXTENSIÓN TRIESTÉREO
3.5MM 1-5M**

Cod. JV-X35Q1-5M



**CABLE AUDIO PLUG
3.5 MM A 3 JACK RCA
HEMBA 15 CM**

Cod. JV-35X3RCA



**EXTENSIÓN AUDIO
3.5 HEMBRA A 2
RCA MACHO**

Cod. JV-2RCAT035



**CABLE USB A 3 RCA
1.5M**

Cod. JV-USBR1-5M



**ADAPTADOR
CONVERTIDOR DE VOLTAJE
5V A 12V 5.5X2.5ML**

Cod. JV-5VT012V



VELOCIDAD 3.0

CABLE VELOCIDAD USB 3.0 PARA DISCO DURO EXTERNO 50CM

Cod. JV-DD50CM



VELOCIDAD 3.0

CABLE VELOCIDAD USB 3.0 PARA DISCO DURO EXTERNO 1MT

Cod. JV-DD1M



CABLE CONVERTIDOR DE ENTRADA MICRO MACHO A HDMI HEMBRA 17CM

Cod. JV-MCT0HDTV17



EXTENSIÓN HDMI HEMBRA A HDMI MACHO 30 CM

Cod. JV-XHDTV-30CM



EXTENSIÓN HDMI CABLE 1.5M (MACHO - HEMBRA)

Cod. JV-XHDTV1-5M



EXTENSIÓN HDMI CABLE 3M (MACHO - HEMBRA)

Cod. JV-XHDTV-3M

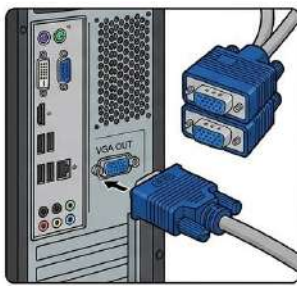

CÓMO USAR EL CABLE DIVISOR VGA Y (CABLE VGA 'YANPO')

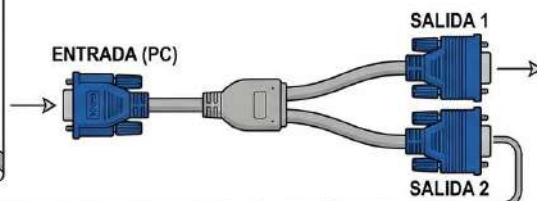

CONEXIÓN A LAPTOP O PC

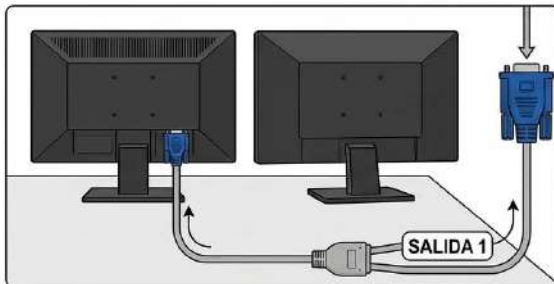

DUPLICACIÓN DE PANTALLA (ESPEJO): MISMA IMAGEN EN DOS DISPOSITIVOS



EXTENSIÓN VGA EN Y PARA 2 MONITORES SENCILLA

Cod. JV-Y-VGA-SE



EXTENSIÓN VGA EN Y PARA 2 MONITORES FINO

Cod. JV-Y-VGA



EXTENSIÓN HDMI EN Y PARA 2 MONITORES

Cod. JV-Y-HDTV



**CABLE USB A PARALELO
(CENTRONICS)**

Cod. JV-USB-PA



**CABLE USB TO RS232
(SERIAL MACHO)**

Cod. JV-SEUSB



**CABLE USB A PUERTO
PARALELO
(CENTRONICS)**

Cod. JV-PAUSB



**CABLE USB A SERIAL
(SERIAL MACHO)**

Cod. JV-USB-SE



CABLE 3.5MM A TIPO C

Cod. JV-35TOC



**CABLE LIGHTNING A
3.5MM AUDIO DIGITAL**

Cod. JV-LT35D



CABLE DIVISOR DE ENTRADA DC HEMBRA X 2 MACHOS

Cod. JV-DC1X2



CABLE DIVISOR DE ENTRADA DC HEMBRA X 3 MACHOS

Cod. JV-DC1X3



CABLE DIVISOR DE ENTRADA DC HEMBRA X 4 MACHOS

Cod. JV-DC1X4



CABLE USB MACHO A DC 5.5X2.5MM - 1M

Cod. JV-DC55X25

-7%



CABLE USB TIPO A MACHO A DC 3.5X1.35MM - 1M

Cod. JV-DC35X135



CABLE USB TIPO MACHO A DC 4.0X1.7MM 1M

Cod. JV-DC4X17

-13%

Cargadores Profesionales

Potencia, compatibilidad y rendimiento para cada equipo.



Amplio portafolio para todas las marcas.
Calidad garantizada para tu negocio.



acer

Lenovo

ASUS



TOSHIBA

DELL



LG

SAMSUNG



CARGADOR PARA MAC 16.5V
3.65A MS2 5PIN 60W

Cod. JV-MAC1

CARGADOR PARA MAC 16.5V
3.65A "L"PIN 60W

Cod. JV-MAC2



CARGADORES PARA PORTÁTILES

-33%



**CARGADOR CON ENTRADA
TIPO C 20V-3,25A 65**

Cod. JVC65W



YANPO[®]
Electronic Technology



**ADAPTADOR
PARA PORTATIL
TIPO C 87W BLANCO**

Cod. JV-AD87W

acer

CARGADORES PARA PORTÁTILES



-7%

acer

**CARGADOR PARA
ACER 19V-3.42A**

5.5x1.7 L Amarilla 65W

Cod. JVAC01

acer

**CARGADOR PARA
MINI ACER 19V-2.15A**

5.5x1.7 L Amarilla 41W

Cod. JVAC02

acer

**CARGADOR PARA
ACER 19V-2.37A**

5.5x1.7 L Amarilla 45W

Cod. JVAC03

acer

**CARGADOR PARA
MINI ACER 19V-1.58A**

5.5x1.7 L Amarilla 30W

Cod. JVAC04



ASUS

**CARGADOR PARA
ASUS 19V-1.75A**

-11%

4.0x1.35 L Negra 33W

Cod. JVAS01



Llegó



ASUS

**CARGADOR PARA
MINI ASUS 19V-1.75A**

-11%

3.0x1.1 L Negra 33W

Cod. JVAS02



ASUS

**CARGADOR PARA
ASUS 19V-3.42A**

4.0x1.35 L Negra 65W

Cod. JVAS03



ASUS

**CARGADOR PARA
ASUS 19V-2.37A**

4.0x1.35 L Negra 45W

Cod. JVAS04





CARGADOR PARA
ASUS 19V-2.37A

-14%

5.5x2.5 L Negra 45W

Cod. JVAS05



CARGADOR PARA
ASUS 19V-3.42A

5.5x2.5 L Negra 65W

Cod. JVAS06



CARGADOR PARA
ASUS USB 19V-1.75A

x205T PUNTA USB

Cod. JVAS09

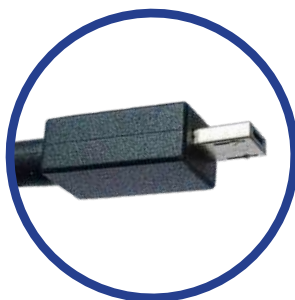

CARGADOR PARA
MINIASUS 19V

3.0x1.1 L Negra 65W

Cod. JVAS731





**CARGADOR PARA
DELL 19.5V-3.34A**

7.4x5.0 Punta Negra 65W

Cod. JVDE01



DELL

**CARGADOR PARA
DELL 19.5V-3.34A**

4.5x3.0 Punta Negra 63W

Cod. JVDE02



DELL

**CARGADOR PARA
DELL PA10 19.5V-4.62A**

7.4x5.0 Punta Negra 90W

Cod. JVDE03





CARGADORES PARA PORTÁTILES



-16%



**CARGADOR PARA
HP 19.5V-2.31A**

4.5x3.0 L Azul 45W

Cod. JVHP01



-VOLTAJE Y AMPERAJE
CONSTANTE.

-LONGITUD DE CABLE:
1.5 METROS

-SISTEMA DE PROTECCIÓN

-CONTRA CORTOS CIRCUITOS

-ABS DE ALTA CALIDAD.

-ETIQUETAS DE IDENTIFICACION.



-13%



**CARGADOR PARA
HP 19.5V-3.33A**

4.5x3.0 L Azul 64W

Cod. JVHP02



**CARGADOR PARA
HP 18.5V-3.5A**

7.4x5.0 Punta Negra 65W

Cod. JVHP03





CARGADORES PARA PORTÁTILES



-17%



**CARGADOR PARA HP
18.5V-3.5A**

**4.8x1.7 Punta Amarilla
65W**

Cod. JVHP04



**CARGADOR PARA
HP 19.5V-4.62A**

4.5x3.0 L Azul 90W

Cod. JVHP05



**CARGADOR PARA
HP 19V-1.58A**

**4.0x1.7 Punta marilla
30W**

Cod. JVHP06



**CARGADOR PARA
HP 19V-4.7A**

**7.4x5.0 Punta Negra
65W**

Cod. JVHP07



Lenovo

**CARGADOR PARA
LENOVO 20V-2.25A**

Punta USB Amarilla 45W

Cod. JVLE01



-10%

Lenovo

**CARGADOR PARA
LENOVO 20V-2.25A**

4.0x1.7 L Negra 45W

Cod. JVLE03



Lenovo

CARGADOR PARA
LENOVO 5V-4A



3.5x1.35 L Negra 20W

Cod. JVLE04



Lenovo

CARGADOR PARA
LENOVO 20V-3.25A



5.5x2.5 L Negra 65W

Cod. JVLE05



-16%



CARGADOR PARA
LENOVO 20V-4.5A

11x4 Punta USB

Cod. JVLE08



Lenovo

CARGADOR PARA
LENOVO 19V-3.42A



5.5x2.5 L Negra 65W

Cod. JVLE06



-11%

Lenovo

CARGADOR PARA
LENOVO 20V-3.25A



4.0x1.7 L Negra 65W

Cod. JVLE09





PARA MONITOR MARCA LG



ADAPTADOR DE VOLTAJE 12V-5A

5.5x2.5 L NEGRA 60W

Cod. JVLG02



CARGADOR PARA MONITOR LG 24V-3A

6.5x4.4 L Negra 72W

Cod. JVLG03



CARGADOR PARA
MONITOR LG 24V-4A

6.5x4.4 L Negra 40W

Cod. JVLG04



-11%



SAMSUNG



**CARGADOR PARA
SAMSUNG 19V-3.16A**

5.5x3.0 - 60W

Cod. JVSA01



SAMSUNG



**CARGADOR PARA
SAMSUNG 19V-2.1A**

**5.5x3.0 Punta
Amarilla 40W**

Cod. JVSA02



SAMSUNG

**CARGADOR PARA MONITOR
SAMSUNG 14V-2.14A**

6.4x4.4 L Amarilla 30W

Cod. JVSA03





TOSHIBA  **Llegó**

TOSHIBA  **Llegó**

TOSHIBA



-25%

**CARGADOR PARA
TOSHIBA 19V-3.42A**

**CARGADOR PARA
TOSHIBA 19V-2.37A**

**CARGADOR PARA
TOSHIBA 19V-3.95A**

5.5x2.5 Negra 65W

5.5x2.5 L Negra 45W

5.5x2.5 Negra 75W

Cod. JVTH01

Cod. JVTH02

Cod. JVTH03

-23%

SONY



**CARGADOR PARA
SONY 19.5V-4.7A**

6.0x4.4 L Amarilla 75W

Cod. JVSY01

SONY



**CARGADOR PARA
SONY 19.5V-3.9A**

6.5x4.4

Cod. JVSY02

SONY



**CARGADOR PARA
SONY 19.5V-2.15A**

6.5x4.4 Punta Amarilla

Cod. JVSY03

Llegó



**ADAPTADOR UNIVERSAL
30W MULTIPLES PUNTAS**

Cod. JV-ADU30W



**ADAPTADOR UNIVERSAL
96W MULTIPLES PUNTAS**

Cod. JV-ADU96W



**ADAPTADOR UNIVERSAL AC
AUTOMATICO**

6.5x4.4 Punta Amarilla

Cod. JV-SY800



**PUNTA PARA ADAPTADOR
PC SAMSUNG**

5.5x3.0

Cod. JV-PSAM1



**PUNTA PARA ADAPTADOR
SAMSUNG**

6.0x4.4

Cod. JV-PSAM2



**PUNTA PARA ADAPTADOR PC
TOSHIBA**

5.5x2.5

Cod. JV-PTOS1



**PUNTA PARA ADAPTADOR
DELL**

7.4x5.0

Cod. JV-PDEL1



**PUNTA PARA
ADAPTADOR ASUS**

4.0x1.35

Cod. JV-PASU1



**PUNTA PARA ADAPTADOR
ASUS**

5.5x2.5

Cod. JV-PASU2



**PUNTA PARA
ADAPTADOR PC
ACER**

5.5x1.7

Cod. JV-PACE1



**PUNTA PARA
ADAPTADOR PC
HP**

4.5x3.0 - 3 HILOS

Cod. JV-PHP1



**PUNTA PARA
ADAPTADOR PC
HP**

4.0x1.7

Cod. JV-PHP2



**PUNTA PARA
ADAPTADOR PC
LENOVO USB**

USB

Cod. JV-PLEN1



**PUNTA PARA
ADAPTADOR PC
LENOVO**

4.0x1.7

Cod. JV-PLEN2



**PUNTA PARA
ADAPTADOR PC
LG**

6.5x4.4

Cod. JV-PLG1



ADAPTADORES DE VOLTAJE

ENTRADA A 110V



ADAPTADOR
3V250+ MA

5.5X2.5mm POSITIVO

Cod. JV-TF3V250+



ADAPTADOR
3V250- MA

5.5X2.5mm NEGATIVO

Cod. JV-TF3V250-



ADAPTADOR
4V75+ MA

5.5X2.5mm POSITIVO

Cod. JV-TF4V75+



ADAPTADOR
4.5V250+ MA

5.5X2.5mm POSITIVO

Cod. JV-TF4-5V250+



ADAPTADOR
4.5V250- MA

5.5X2.5mm NEGATIVO

Cod. JV-TF4-5V250-



ADAPTADOR
6V250+ MA

5.5X2.5mm POSITIVO

Cod. JV-TF6V250+

ENTRADA A 110V



**ADAPTADOR
6V250- MA**

5.5X2.5mm NEGATIVO

Cod. JV-TF6V250-



**ADAPTADOR
3V400+ MA**

5.5X2.5mm POSITIVO

Cod. JV-TF3V400+



**ADAPTADOR
3V500+ MA**

5.5X2.5mm POSITIVO

Cod. JV-TF3V500+



**ADAPTADOR
4.5V400+ MA**

5.5X2.5mm POSITIVO

Cod. JV-TF4-5V200+



**ADAPTADOR
6V500+ MA**

5.5X2.5mm POSITIVO

Cod. JV-6V500+



**ADAPTADOR
6V500- MA**

5.5X2.5mm NEGATIVO

Cod. JV-6V500-

ENTRADA A 110V



ADAPTADOR 9V500+ mA

5.5X2.5mm POSITIVO

Cod. JV-TF9V500+



ADAPTADOR 12V200+ MA

5.5X2.5mm POSITIVO

Cod. JV-TF12V200+



ADAPTADOR
CONVERTIDOR DE VOLTAJE
5V A 12V 5.5X2.5ML

Cod. JV-5VT012V



FUENTE DE PODER
12V-5A PEQUEÑA

Cod. JV-FP12V5A



FUENTE DE PODER 12V-10A
GRANDE

Cod. JV-FP12V10A



FUENTE DE PODER 12V-20A
GRANDE

Cod. JV-FP12V20A

PANTALLA
LED



-21%

ADAPTADOR DE VOLTAJE
REGULADO 3-12V 5A

Cod. JV-AD3-12V5A

PANTALLA
LED



-21%

ADAPTADOR DE VOLTAJE
REGULADO 9-24V 3A

Cod. JV-AD9-24V3A

BAJÓ

TIPO PESADO



ADAPTADOR DE
VOLTAJE 12V-3A

5.5x2.5

Cod. JV-AD12V3A

-11%



TIPO PESADO



ADAPTADOR DE
VOLTAJE 15V-4A

5.5x2.5

Cod. JV15V4A



TIPO PESADO



ADAPTADOR DE
VOLTAJE 24V-3A

72 WATTS

3 PINES

Cod. JV24V3A3P



TIPO PESADO



ADAPTADOR DE
VOLTAJE 24V-3A

72 WATTS

5.5x2.5

Cod. JV24V3A



Indicador
LED

ADAPTADOR DE
VOLTAJE 5V-3A

5.5x2.5

Cod. JV-5V3A



Indicador
LED

ADAPTADOR DE
VOLTAJE 5V-5A

5.5x2.5

Cod. JV-5V5A



Indicador
LED

ADAPTADOR DE
VOLTAJE 9V-3A

5.5x2.5

Cod. JV-9V3A



Indicador
LED

ADAPTADOR DE
VOLTAJE 9V-5A

5.5x2.5

Cod. JV-9V5A



Indicador
LED

ADAPTADOR DE
VOLTAJE 12V-5A

5.5x2.5

RECOMENDADO PARA LUCES
LED Y NEÓN

Cod. JV-12V5APE



Indicador
LED

**ADAPTADOR DE
VOLTAJE 15V-3A**

5.5x2.5

Cod. JV-15V3A



Indicador
LED

**ADAPTADOR DE
VOLTAJE 15V-5A**

5.5x2.5

Cod. JV-15V5A



Indicador
LED

**ADAPTADOR DE
VOLTAJE 24V-3A**

5.5x2.5

Cod. JV24V3APE



Indicador LED

**ADAPTADOR TIPO
REGLETA 6V-2A**

5.5x2.5

Cod. JV-6V2ATH



**ADAPTADOR 5V1A
CON DOBLE PUNTA**

5.5x2.5 - 4.0x1.7

Cod. JV-5V1AT



**ADAPTADOR 5V2A
CON DOBLE PUNTA**

5.5x2.5 - 4.0x1.7

Cod. JV-5V2AT



**ADAPTADOR 9V1A
DOBLE PUNTA**

5.5x2.5 - 4.0x1.7

Cod. JV-9V1AT



**ADAPTADOR 9V2A
DOBLE PUNTA**

5.5x2.5 - 4.0x1.7

Cod. JV-9V2AT



**ADAPTADOR 12V1A
CON DOBLE PUNTA**

5.5x2.5 - 4.0x1.7

Cod. JV-12V1AT



ADAPTADOR 12V2A
CON DOBLE PUNTA
5.5x2.5 - 4.0x1.7

Cod. JV-12V2AT



ADAPTADOR DE
VOLTAJE 5V-1A
5.5x2.5

Cod. JV-5V1A



ADAPTADOR DE
VOLTAJE 5V-2A
5.5x2.5

Cod. JV-5V2A



ADAPTADOR DE
VOLTAJE 5V-2A
TIPO SAMSUNG
Conector TIPO SAMSUNG

Cod. JV-5V2A-V8



ADAPTADOR DE
VOLTAJE 5V-2A
4.0x1.7

Cod. JV-5V4X17



ADAPTADOR DE
VOLTAJE 5V-2A

3.5x1.35

Cod. JV-5V2A135



ADAPTADOR DE
VOLTAJE 9V-1A

5.5x2.5

Cod. JV-9V1A



ADAPTADOR DE
VOLTAJE 9V-2A

5.5x2.5

Cod. JV-9V2A



ADAPTADOR DE
VOLTAJE 9V 1A

4.0x1.7

PUNTA AMARILLA

Cod. JV-9V1A4X17



ADAPTADOR DE
VOLTAJE 9V-2A

4.0x1.7

Cod. JV-9V2A4X17



ADAPTADOR DE
VOLTAJE 12V-1A

5.5x2.5

Cod. JV-12V1A



ADAPTADOR DE
VOLTAJE 12V-2A

5.5x2.5

Cod. JV-12V2A



ADAPTADOR DE
VOLTAJE 12V-1.5A

5.5x2.5

Cod. JV-12V1-5A



ADAPTADOR DE
VOLTAJE 12V-2A

4.0x1.7

Cod. JV-12V2A4X17



ADAPTADOR DE
VOLTAJE 12V-3A

5.5x2.5

Cod. JV-12V3A-PE



ADAPTADOR DE
VOLTAJE 15V-1.5A

5.5x2.5

Cod. JV-15V1-5A



ADAPTADOR TIPO
REGLETA 5V-1A

5.5x2.5

Cod. JV-5V1ATH



ADAPTADOR TIPO
REGLETA 5V-2A

2.5x0.7

Cod. JV-5V2A-TTH



ADAPTADOR
5V 2A - 5.5X2.5MM
TIPO REGLETA V8

Cod. JV-5V2ATH-V8



ADAPTADOR TIPO
REGLETA 5V-2A

5.5x2.5

Cod. JV-5V2ATH



ADAPTADOR TIPO
REGLETA 9V-1A

5.5x2.5

Cod. JV-9V1ATH



ADAPTADOR TIPO
REGLETA 9V-2A

5.5x2.5

Cod. JV-9V2ATH



ADAPTADOR TIPO
REGLETA 9V-1A

4.0x1.7

Cod. JV-9V1ATH-417

PUNTA 4.0x1.7mm



ADAPTADOR TIPO
REGLETA 9V-2A

4.0x1.7

Cod. JV-9V2A4X17TH



ADAPTADOR TIPO
REGLETA 12V-1A

5.5x2.5

Cod. JV-12V1ATH



ADAPTADOR TIPO
REGLETA 12V-1.5A

5.5x2.5

Cod. JV-12V1-5ATH

-5%



ADAPTADOR TIPO
REGLETA 12V-2A

5.5x2.5

Cod. JV-12V2ATH

PUNTA 4.0x1.7mm



ADAPTADOR TIPO
REGLETA 12V-2A

4.0x1.7

Cod. JV-12V2A4X17TH



ADAPTADOR TIPO
VOLTAJE 15V-1.5A

5.5x2.5

Cod. JV-15V1-5ATH



**ADAPTADOR UNIVERSAL
30W MULTIPLES PUNTAS**

Cod. JV-ADU30W



**ADAPTADOR UNIVERSAL
96W MULTIPLES PUNTAS**

Cod. JV-ADU96W



**ADAPTADOR UNIVERSAL
AC AUTOMATICO**

Cod. JV-SY800



**SOLO PARA
BATERIA RECARGABLE
SECA 6V 1A HASTA 5A**

**CARGADOR PARA
BATERÍAS
6 V - 1 A**

**¡SIN GARANTÍAS!
SE ENVIA ENSAYADO**

Cod. JV-CA6V1A





YANPO[®]
ELECTRONIC TECHNOLOGY

ADAPTADORES Y CONVERTIDORES

El puerto de nuestro celular puede darnos más usos si contamos con el cable o adaptador correcto, desde transferir archivos a conectar periféricos.

Estos conectores tienen muchos usos y diversas aplicaciones, facilitando la conexión con varios dispositivos.



CONECTOR OTG TIPO C

Cod. JV-OTG-TIPOC



CONVERTIDOR USB A
TIPO C (OTG)

Cod. JV-USB-TIPOC



CONVERTIDOR MICRO A
TIPO C

Cod. JV-MICRO-TIPOC



CONVERTIDOR TIPO C
HEMBRA A USB 3.0 MACHO

Cod. JV-3CHUSBM



CABLE USB 2.0 MACHO
A TIPO C HEMBRA

Cod. JV-CA3CHUSBM



LECTOR DE TARJETA
5 EN 1

Cod. JV-LECTA

-5%



¡Llegó

TARJETA DE SONIDO 7.1

Cod. JV-TJ71-VOL

¡Llegó



TARJETA DE SONIDO USB TIPO AVIÓN

Cod. JV-TJ7-1AV

-9%



TARJETA DE SONIDO 5.1

Cod. JV-TJ5-1

-47%



Conector TIPO C

TARJETA SONIDO 7.1 TIPO C

Cod. JV-TJC7-1

-9%



**TARJETA DE SONIDO TIPO USB
7 CANALES**

Cod. JV-TJGL7-1

-10%



Conector USB

ADAPTADOR DE SONIDO 7.1 BLANCO USB

Cod. JV-TJ7-1C



SPLITER 1X2 PARA CABLE OPTICO

Cod. JV-Y-OP

-13%



ADAPTADOR TRANSMISOR Y RECEPTOR INALÁMBRICO 2 EN 1 CON BLUETOOTH DUAL

Cod. JV-RCTR

Llegó



CONVERTIDOR DE AUDIO OPTICO A RCA

Cod. JV-DGTOAN



SWITCH VGA 1 X 2

Cod. JV-VGA1X2



SWITCH VGA 1 X 4

Cod. JV-VGA1X4



SWITCH HDMI X 3 CONTROL

Cod. JV-HDTV-SW3

-31%

Llegó



INPUT
RCA



CONVERTIDOR RCA TO VGA



Cod. JV-RCATOVGA



INPUT
RCA



CONVERTIDOR RCA A HDMI

Cod. JV-AVTOHDTV



INPUT
HDMI



CONVERTIDOR HDMI A RCA

Cod. JV-HDVTORCA



INPUT
HDMI



CONVERTIDOR HDMI A VGA

Cod. JV-HDVTOVGA

-15%



CONVERTIDORA VGA+AUDIO TO HDMI

Cod. JV-VGATOHDTV



INPUT
VGA



CONVERTIDOR VGA TO RCA

Cod. JV-VGATORCA



MÓDULO USB BLUETOOTH RADIO 12V

Cod. MOD-USB



ADAPTADOR DISPLAY PORT A HDMI

Cod. JV-DPTOHDTV



CONVERTIDOR HDMI A VGA SENCILLO

Cod. JV-HDTVTOVGA-SE



CONVERTIDOR HDMI A VGA CON AUDIO

Cod. JV-HDTVTOVGA-YP

Electronic Technology



CONVERTIDOR HDMI A VGA BLISTER NARANJA

Cod. JV-HDTVTOVGA-NA



SWITCH USB IMPRESORA 2 PUERTOS

Cod. JV-SWIMP2

-7%



SUICHE IMPRESORA 4 PUERTOS

Cod. JV-SWIMP4

SPLITTER HDMI 2 PUERTOS FINO

Cod. JV-SPT-1X2



SPLITTER HDMI 8 PUERTOS FINO

Cod. JV-SPT-1X8



SPLITTER 1 ENTRADA X 2 SALIDAS ULTRA HD - 4K

Cod. JV-HDTV-1X2



EXTENDER HDMI CON AUDIO 60M

Cod. JV-KVM-60M



EXTENDER HDMI CON AUDIO 120M

Cod. JV-KVM-120M



CONVERTIDOR EXTENDER "CABLE LAN" HDMI 30M 1 LINEA V1.4

Cod. JV-EX30M



EXTENDER DE USB A RJ45 - 30 M

Permite alargar una extensión USB usando cable UTP.

Cod. JV-EXRJ45



EXTENDER HDMI RJ45 HASTA 30M

Cod. JV-HDTVEXRJ45



EXTENDER PARA IMPRESORA POR RJ45

Cod. JV-EXIMPRESA

-31%



ADAPTADOR MICRO HDMI A VGA

entrada con puerto micro hdmi
con salida vga

Cod. JV-MIHDTVTOVGA

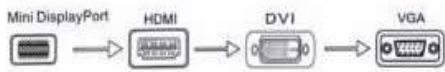

CONVERTIDOR DE MINI DISPLAY PORTA VGA + HDMI + DVI

Cod. JV-MDPMUL



CONVERTIDOR TIPO C A HDMI+PD+VGA+USB

Cod. JV-TIPOC-400



TYPE-C A HDMI, TYPE-C 3.0 Y USB 3.0 - 3 IN 1 PARA DISPOSITIVOS DE ALTA GAMA

Cod. JV-CTOHDTV-3



CONVERTIDOR TIPO C A HDMI+VGA

Cod. JV-TIPOC-200



**CONVERTIDOR TIPO USB A
HDMI+VGA+AUDIO**

Cod. JV-USB-200



ADAPTADOR DISPLAY PORT A VGA

Cod. JV-DPTOVGA

24+1



**CONVERTIDOR DE ENTRADA DVI (24+1)
MACHO A HDMI HEMBRA 30CM**

Cod. JV-DVITOHDTV-30

24+1



24+1 DVI TO VGA

Cod. JV-DVITOVGA



BLUETOOTH DONGLE USB

solo conexión bluetooth

Cod. JV-BTUSB



ADAPTADOR BLUETOOTH 5.0

conexión usb. 5.0

Cod. JV-DONGLE5-0



ADAPTADOR BLUETOOTH A AUX 3.5

conexión usb para corriente y funciona con 3.5mm

Cod. JV-BTH



ADAPTADOR BLUETOOTH 3.5MM Y USB RECEPTOR-DOBLE FUNCIÓN

funciona con cable 3.5mm y con bluetooth

Cod. JV-BTHX2



CONVERSOR TIPO C A DVI

Cod. JV-CTODVI



CONVERSOR TIPO C A DISPLAY PORT

Cod. JV-CTODP



CONVERSOR TIPO C A VGA

Cod. JV-CTOVGA

-12%



CAPTURADORA HDMI TIPO C Y USB 4K

Cod. JV-CPX3

-16%



CAPTURADORA VIDEO HDMI

Cod. JV-CPHDMI



EXTENDER HDMI 60M CABLE LAN

Cod. JV-EXHDTV-60M



**ADAPTADOR USB A RJ45 USB2.0
REAL DRIVE INCLUIDO**

Cod. JV-USBTORJ452

-11%



Llegó

ADAPTADOR USB A RJ45

Cod. JV-BUSBTORJ45

BAJÓ



CONVERTIDOR DE USB A RJ45 V 3.0

10/100/1000 MBPS

Cod. JV-USBRJ45V3



ADAPTADOR TIPO C A RJ45

presentación en blíster.usb 2.0.

Cod. JV-CRJ45



CONVERTIDOR TIPO C A RJ45 3.0

10/100/1000 mbps

Cod. JV-CRJ45-3-0



ADAPTADOR CRJ45 ENTRADA TIPO C

3 puertos usb hub

Cod. JV-CRJ45H



ADAPTADOR MINI DISPLAY PORT A VGA

Cod. JV-MDPTOVGA



ADAPTADOR MINI DISPLAY PORT A HDMI

Cod. JV-MINIDIS-HDTV



CONVERTIDOR USB A VGA

Cod. JV-USBTOVGA



CONVERTIDOR USB A HDMI

Cod. JV-USBTOHDTV



CONVERTIDOR HDMI A VGA YANPO

Cod. JV-PEHDTV2VGA



CAPTURADORA DE VIDEO RCA

Cod. JV-CPRCA



24+5

ADAPTADOR DVI A VGA (24+5)

Cod. JV-DVI-VGA5



24+1

ADAPTADOR DVI A HDMI

Cod. JV-DVI-HDTV



CABLE USB SATA SENCILLO

Cod. JV-SATA-T1



USB TO MINI SATA

Cod. JV-MINISATA



**CABLE ADAPTADOR
SATA A USB 3.0**

Cod. JV-SATA3

BAJÓ



ANTENA WIFI MINI

Cod. JV-AN300



ANTENA WIFI 150MB

permite dotar a la cpu de wifi.

Cod. JV-ANWIFI300

-13%



ANTENA WIFI 600MB

permite dotar a la cpu de wifi.

Cod. JV-ANWIFI600



ANTENA WIFI 600MBPS DUAL BAND

Cod. JV-WIFI-DUAL



ADAPTADOR USB TO PS2

Cod. JV-USB-PS2



HDMI DONGLE

permite dotar a la cpu de wifi.

Cod. JV-CHROMECAST



HDMI DONGLE

Cod. JV-ANYCAST



REPETIDOR HDMI

soporta señal 1080p y 4k

Cod. JV-HDTV-RP



WIFI SMART SWITCH

Cod. JV-WIFIS



ADAPTADOR DE CORRIENTE 3 SALIDAS

Cod. JV-SPT110



CONECTOR REDONDO A PLANO

Cod. JV-RETOPL



CONECTOR SMART SWICHTH

Cod. JV-SMWIFI



CONECTOR PATA PLANA CLAVIJA EUROPEA

Cod. JV-ADEU



ADAPTADOR VIAJERO

Cod. JV-AD-VJ



ADAPTADOR VIAJERO 2 USB

Cod. JV-VJ-2USB



UNION BNC

Cod. JV-UBNC



CONECTO BNC PARA CAMARA

Cod. JV-CBNC



✓ Llegó

-17%



VIDEO BALUM PARA RJ45

con blister

Cod. JV-VBRJ45

VIDEO BALUM DE TORNILLO BLISTER

Cod. JV-VB400

-11%



VIDEO BALUM 8MP 1080P

Cod. JV-VB8MP



VIDEO BALUM

video balum conector dorado 600mt empaque blíster.

Cod. JV-VBT600



**Color:
BLANCO**

**CABLE PARA CAMARA CCTV
ENERGIA Y VIDEO 10M**

Cod. JV-CACCTV-10M



**Color:
BLANCO**

**CABLE PARA CAMARA CCTV
ENERGIA Y VIDEO 20M**

Cod. JV-CACCTV-20M



YANPO[®]
ELECTRONIC TECHNOLOGY

MISCELANEA TECNOLÓGICA

MAQUINA DE HUMO CON LUCES LED 700W



Equipo Profesional Diseñado Para Su Uso En Conciertos, Fiestas Y Eventos Para Crear Efectos De Niebla Y Ambientación. Esta Máquina De Humo Está Equipada Con Una Potente Bomba Que Puede Generar Una Gran Cantidad De Niebla En Poco Tiempo, Lo Que La Hace Ideal Para Espectáculos En Vivo.

Cod. JV-FOG-700

MAQUINA DE HUMO CON LUCES LED 500W



Esta Equipada Con Un Potente Cabezal Que Permite Una Iluminación Clara Y Brillante En Cualquier Dirección. El Cabezal Es Fácilmente Ajustable, Lo Que Significa Que Puedes Crear Una Variedad De Efectos E Iluminación En Un Instante Y Crear Un Ambiente Espectacular Y Emocionante.

Cod. JV-LED-500

MAQUINA DE HUMO CON 24 LUCES LED



Esta Máquina De Humo Puede Generar Una Salida De Humo De 20,000 Pies Cúbicos Por Minuto, Lo Que La Convierte En Una De Las Máquinas De Humo Más Potentes Del Mercado. Cuenta Con Una Capacidad De 2.5l De Aceite En Su Tanque

Cod. JV-FOG-24

MAQUINA DE HUMO CON BURBUJAS



La Máquina De Burbujas De Humo Puede Generar Más De 8000 Burbujas Por Minuto Con Un Motor Súper Integrado. Puede Soplar Toneladas De Burbujas Coloridas O Burbujas De Niebla Más Rápido, Más Alto Y Más Lejos Incluso En El Interior Sin Viento.

Cod. JV-FOG-BUBBLE



MINI MOUSE USB LED

cable conexión usb, led y scroll

Cod. JV-SEMOU

-7%



MOUSE ALAMBRICO OFICINA OP-10

Cod. JV-OP-10



MOUSE ALAMBRICO OFICINA

Cod. JV-V13

-6%



MOUSE ALÁMBRICO

Cod. JV-V12



MOUSE USB M10 CABLE

Tacto cómodo. Clic suave.

Cod. JV-M10



MOUSE ALÁMBRICO

Cod. JV-M022



MOUSE INALAMBRICO PARA OFICINA 1600 DPI

Cod. JV-W927



MOUSE INALAMBRICO Q2

Cod. JV-Q2

\$13.900



MOUSE OFICINA INALAMBRICO NEGRO

Cod. JV-BX2

\$ 13.500



MOUSE INALAMBRICO Q4

Cod. JV-Q4

\$ 13.600



MOUSE INALAMBRICO Q18

radio frecuencia: 2.4ghz - solo negro

Cod. JV-Q18

\$ 16.500



MOUSE INALAMBRICO Q5

Cod. JV-Q5

\$ 21.900



MOUSE USB CON CABLE VERTICAL

Cod. JV-VT

\$21.800



**MOUSE VERTICAL INALÁMBRICO
PILA AA - NO INCLUIDA**

Cod. JV-WRVT



MOUSE INALAMBRICO LAPICERO 2.4G

Cod. JV-MLP



MOUSE OPTICO ALAMBRICO 1600 DPI

Cod. JV-FC-3039



MOUSE ALAMBRICO V1

Cod. JV-V1



**MOUSE GAMER ALAMBRICO
3D 1.200 DPI OP-20 BLANCO**

Cod. JV-OP-20W



**MOUSE GAMER ALAMBRICO 4D
1.600 DPI X3**

Cod. JV-X3



**MOUSE GAMER
ALÁMBRICO 6D LED**

Cod. JV-G560



**MOUSE GAMER
ALAMBRICO
6D 3.200 DPI G502**

Cod. JV-G502



**MOUSE GAMER
ALÁMBRICO 7D**

Cod. JV-M1



**MOUSE GAMER ALAMBRICO
6D 3.200 DPI G402**

Cod. JV-G402



**MOUSE GAMER
INALÁMBRICO 6D 2.400 DPI**

Cod. JV-Q3



**TECLADO MINI
ALÁMBRICO**

Cod. JV-K1000



TECLADO FLEXIBLE

Cod. JV-F3



TECLADO BLUETOOTH

Cod. JV-BLKEY



TECLADO GAMER ALÁMBRICO

Cod. JV-T20



TECLADO USB DE OFICINA

Cod. JV-K29



TECLADO USB DE OFICINA

Cod. JV-T130



TECLADO GAMER PARA UNA MANO ALÁMBRICO

Cod. JV-T19



**TECLADO ALÁMBRICO
ESPAÑOL**

Cod. JV-K122



**KEYBOARD K200
ALÁMBRICO**

viene con la letra ñ

Cod. JV-K200



**TECLADO ALÁMBRICO
ESPAÑOL**

Cod. JV-KB580

YANIP®



**COMBO TECLADO Y MOUSE
INALÁMBRICO ESPAÑOL**

Cod. JV-H-518



**COMBO TECLADO Y MOUSE
ALÁMBRICO ESPAÑOL**

Cod. JV-K9100



TECLADO ALÁMBRICO

viene con la letra ñ

Cod. JV-NKEY



TECLADO INALÁMBRICO

compatible con windows, linux, mac os, android. 2.4ghz. rango de 15 metros. incluye 92 teclas.

Cod. JV-TCA



TV BOX X96MINI 4K 16GB+2RAM

convierte tu televisor en smart tv, android

Cod. JV-X96



TV BOX, SET-TOP BOX 4K 16GB+2RAM ANDROID + SMART TV

convierte tu televisor en smart tv, android

Cod. JV-MX10



TV BOX, TV STICK 4K 16GB+2RAM ANDROID + SMART TV

convierte tu televisor en smart tv, android

Cod. JV-XS97S3



MEMORIA CON JUEGOS RETRO DE 10,000 JUEGOS Y 2 CONTROLES

Cod. JV-GAMESTICK

-14%



CAJA DISCO DURO 2.5" PARA USB 2.0

para conectar disco duro de portátil a un puerto usb

Cod. JV-USB2-0

-8%



CAJA DISCO DURO 2.5" PARA USB 3.0 SATA 2.5"

VELOCIDAD 3.0

Cod. JV-USB3-0

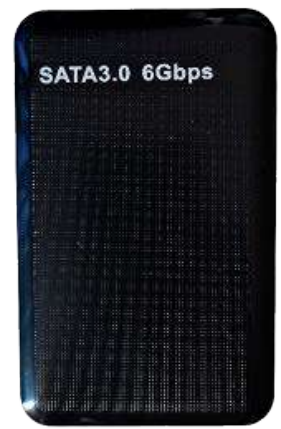

CAJA PARA DISCO DURO NEGRA SATA 2.5"

VELOCIDAD 3.0

Cod. JV-USB3-0C

-20%



CAJA ACRILICA SATA 2.5 A 2.0

diferentes colores. compatible con pc y mac.

Cod. JV-USB2-0A



CAJA PARA DISCO DURO USB 3.0 TRANSPARENTE

Cod. JV-USB3-0A



CONVERTIDOR USB A SATA /IDE

Cod. JV-SATA-IDE



**MEMORIA SD 32GB
CLASE 10 ALTA VELOCIDAD**

Cod. JV-MTF32GB



**MEMORIA USB 2.0
FLASH DRIVE 32GB**

Cod. JV-USB32GB2-0



**MEMORIA USB 2.0
FLASH DRIVE 64GB**

Cod. JV-USB64GB2-0



**MEMORIA USB 3.1
FLASH DRIVE 64GB**

Cod. JV-USB64GB3-1

-15%



**OTG TIPO C -USB, SD,
TF**

Cod. JV-OTG-2



**OTG TIPO C - USB,
MICRO USB, TF**

Cod. JV-OTG-1



**SOPORTE PARA DISCO DURO
CADDY 9.5MM.**

Cod. JV-CBS

YANIPPO®

-15%



**SOPORTE PARA DISCO
DURO CADDY 12,7MM**

Cod. JV-CBS12-7



**QUEMADOR DVD
EXTERNO 3.0**

ENTRADA USB Y TIPO C

Cod. JV-DVDBL



**PAD MOUSE
SENCILLO**

Cod. JV-SEPAD



**PAD MOUSE GEL
COLORES**

Cod. JV-PADGEL



**MICRÓFONO USB
ECONÓMICO**

Cod. JV-USB-MIC



**MICROFONO
COMPUTADOR**

Cod. JV-MC-PC



**MICRÓFONO PARA
COMPUTADOR ECONÓMICO**

Cod. JV-MC-TB



MICROFONO PARA CELULAR
UNIDIRECCIONAL ESTEREO

Cod. JV-MC-ES



MICROFONO DE SOLAPA
longitud 1.20m.

TRIESTEREO

Cod. JV-MC-CL



MICROFONO TRIESTEREO
CELULAR

Cod. JV-MC-CL2



MICROFONO SOLAPA
TIPO C

Cod. JV-MC-CLC



MICROFONO BLUETOOTH PARA
CELULAR TIPO C

Cod. JV-K8



DOS MICROFONOS BLUETOOTH
PARA CELULAR - DOBLE TIPO
C - IPHONE

Cod. JV-K9



VENTILADOR BUJE DE 3" DC 0.10 AMP, 6.4W 24V. PLASTICO

Cod. YP-VE24V3P



VENTILADOR BUJE DE 3" A 12V. DC 0.18AMP, 6.4W. PLASTICO

Cod. YP-12V3P



VENTILADOR DE BALINERAS A 110V 3" AC 0.15A AMP. METÁLICO.

Cod. YP-110V3P



REJILLA PARA MINIVENTILADOR

Cod. YP-GR110V3P



VENTILADOR O EXTRACTOR DE AIRE AXIAL METÁLICO 6-3/4", 0.40AMP - 110V. MEDIDAS: 17.2X15.2X5.1 CM. 5 ASPAS.

Cod. YP-VE110V6P



**VENTILADOR COOLER 12CM
RGB**

Cod. JV-VTRGB

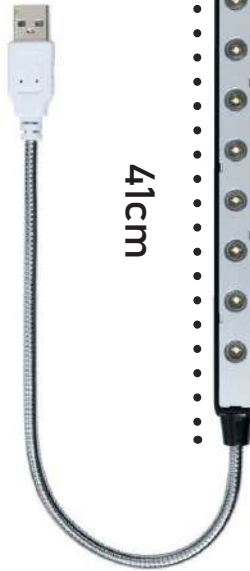

LÁMPARA USB

practico para conectarlo al pc o al
portátil.

10 bombillos led

Cod. JV-USB-LP



LÁMPARA USB

para portátiles y consolas. múltiples
USOS.

Se despachan colores surtidos

Cod. JV-LPCOL

YANIPPO[®]
Electronic Technology



**SUICHE DE RED CINCO
PUERTOS
10/100**

Cod. JV-SW5P



**SUICHE DE RED OCHO
PUERTOS
10/100**

Cod. JV-SW8P

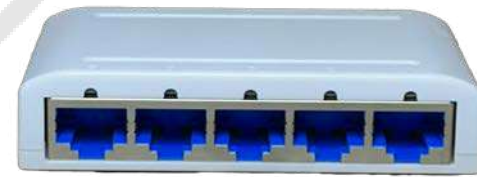

**SUICHE DE 5 PUERTOS
10/100/1000 MS105G**

Cod. JV-1000SW5P

BAOFENG



**2 RADIOS BAOFENG BF-888S
WALKIE TALKIE
INCLUYE AUDÍFONOS**

Impedancia de la antena: 50ohm estimada
Voltaje de salida: 3.7 V DC
Tipo de Batería: batería de litio
Capacidad de batería: 1500 mAh / Color: Negro
Rango de frecuencia: UHF 400 - 470 MHz Memoria
Canal: 16 CTCSS/DCSV

Cod. JV-WKTK



NO INCLUYE
ARO DE LUZ



**TRIPODE PARA ARO DE LUZ
(NO INCLUYE ARO DE LUZ)**

Cod. JV-TRP-ARO

1,02 M



TRIPODE PARA CELULAR ABS

*Trípode regulable
Altura Máx. 1,02 MT.*

Cod. JV-TRPD

DOS AROS
DE LUZ LED



**SOPORTE TRIPODE PARA
CELULAR CON CONTROL**

1.50m dos aros luz led/360°/foto-
video/bt

Cod. JV-JC-18H



BASE PARA PORTÁTIL

Material ABS

Cod. JV-ST001



**BASE PARA PORTÁTIL
EN ABS - PLEGABLE**

Material ABS

Cod. JV-BSABS



**BASE PARA TABLET
O CELULAR METALICA**

Cod. JV-TS18



**BASE PARA TABLET O
CELULAR
METALICA 360°**

Cod. JV-TS18-360

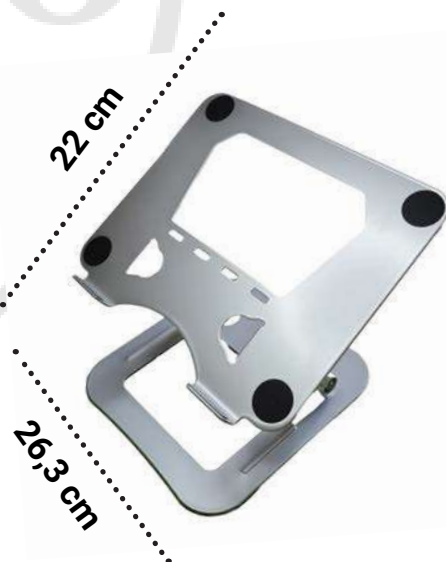

**BASE PARA TABLET Y
COMPUTADOR METALICO**

Cod. JV-LP22



**MESA PARA PORTATIL CON
BASE REFRIGERANTE**

Cod. JV-LD09



**BASE CON CUATRO VENTILADORES
PARA COMPUTADOR**

Cod. JV-X4



**BASE CON UN VENTILADOR
PARA COMPUTADOR**

Cod. JV-NCP-063

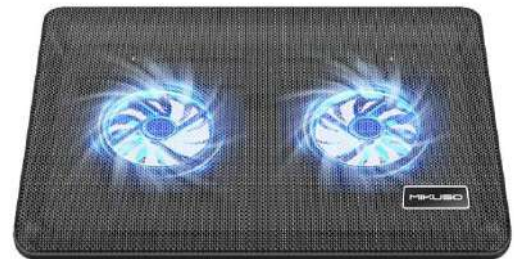

**BASE CON DOBLE VENTILADOR PARA
COMPUTADOR**

Cod. JV-NCP-064



APUNTADOR LASER

Cod. JV-POINTER



**KIT DE LIMPIEZA EXPERT ON
CLEANING SCREEN.**

Cod. JV-KITLP



FUNDA PARA PORTATIL 13"

Cod. JV-FD13



PROTECTOR PARA
TECLADO 14"

Cod. JV-KP14



PROTECTOR PARA
TECLADO 15"

Cod. JV-KP15



GUAYA CON LLAVE

Cod. JV-GUAYA



GUAYA CON CLAVE

Cod. JV-GYCL

YANPO[®]
ELECTRONIC TECHNOLOGY

DIADEMAS

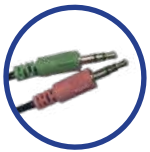

CON ENTRADA JACK

DIADEMA COMPUTADOR 989

Cod. JV-DM3

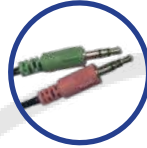

CON ENTRADA JACK

DIADEMA COMPUTADOR TUCCI

Sonido de alta fidelidad.
Control de volumen.

Cod. JV-DM1



CON ENTRADA JACK

DIADEMA COMPUTADOR

Conectores de micrófono,
control de volumen.

Cod. JV-L780



CON ENTRADA JACK

DIADEMA GAMER

Conectores de micrófono,
control de volumen.

Cod. JV-DM2

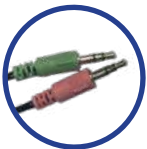

CON ENTRADA JACK

DIADEMA COMPUTADOR GAMING

Sonido de alta fidelidad

Cod. JV-A65



CON ENTRADA TIPO USB

DIADEMA COMPUTADOR USB

Control de volumen.
CONECTOR USB

Cod. JV-TC-Q4



YANPO[®]
ELECTRONIC TECHNOLOGY

**ACCESORIOS
PARA CELULAR**



- Distancia de trabajo: 10-15 Metros
- * Tiempo de carga: 1-2 horas
- * Moderno diseño ergonómico para múltiples posiciones.
- * Materiales ABS de alta calidad, cuerpo ligero y cómodo.
- * Ajustables a oreja derecha o izquierda.
- * 3 micrófonos antirruidos Windsmart para unas conversaciones nítidas.

MANOS LIBRES BLUETOOTH

UN (1) SOLO AURICULAR

Cod. JV-MBT01



AUDIFONO Y MICROFONO INALAMBRICO PARA CASCO/ HANDS FREE

Cod. JV-WREA



Jack de Audio



Control de Volumen.

MANOS LIBRES BLANCO CON AMARILLO SILICONADO

Tamaño del altavoz: 10 mm
Rango de frecuencia: 18-20 000 Hz
Sensibilidad: 116±3dB
Impedancia: 32 Ohm
Longitud del cable: 130 cm

Cod. JV-MD-L024



Jack de Audio



Botón Finalizar Llamada.

MANOS LIBRES CORDON

Tamaño del altavoz: 10 mm
Rango de frecuencia: 20Hz-20KHz
Sensibilidad: 95dB±3
Impedancia: 16 Ohm
Longitud del cable: 135 cm

Cod. JV-MD-L005



Jack de Audio



Botón Finalizar Llamada.

MANOS LIBRES CORDON

Tamaño del altavoz: 10 mm
Rango de frecuencia: 20Hz-20KHz
Sensibilidad: 95dB±3
Impedancia: 16 Ohm
Longitud del cable: 135 cm

Cod. JV-MD-L006

-11%

Llegó



Jack de Audio

MANOS LIBRES

Botón universal.
Control de volumen.

Cod. JV-ML-SG



MANOS LIBRES TIPO LIGHTNING

Botón universal.
Control de volumen.

Cod. JV-IPEPC

Material ABS



SOPORTE DE CELULAR PARA MESA MG06

Cod. JV-MG06

Material ABS



14CM

SOPORTE MINI PARA CELULAR GRADUABLE

Cod. JV-MINI PI

Material ABS



SOPORTE PARA CELULAR GRADUABLE PARA ESCRITORIO

Cod. JV-CT007

Material Metal+ABS



SOPORTE CELULAR ESCRITORIO CT015

Cod. JV-CT015

Material
Metal+ABS



Ajuste de Altura



**SOPORTE CELULAR
ESCRITORIO CT014**

Cod. JV-CT014

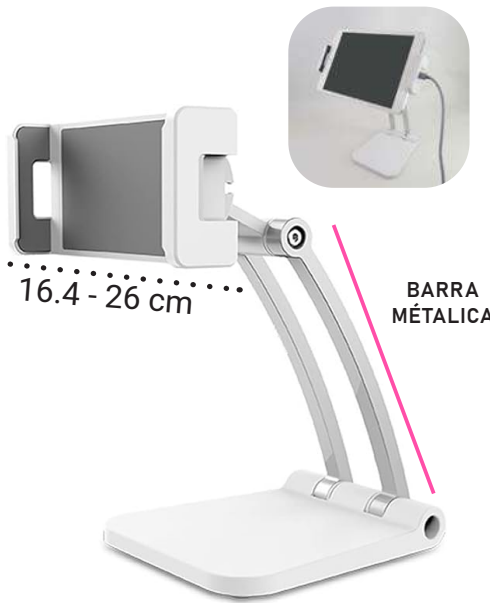

16.4 - 26 cm

BARRA
MÉTALICA

**SOPORTE PARA
TELEFONO/TABLET**

METÁLICO

Cod. JV-LK-613M



**SOPORTE PARA CARRO
360° CON CHUPA**

Cod. JV-CZ031



-6%



**SOPORTE PARA CELULAR
CARRO**

Cod. JV-RT602



**SOPORTE TABLET PARA
ASIENTO DE CARRO**

Cod. JV-HRCAR



Material ABS



**SOPORTE CELULAR PARA
BICICLETA**

PEQUEÑO 360°

Cod. JV-CT023



Material ABS



**SOPORTE CELULAR
PARA BICICLETA**

GRANDE 360°

Cod. JV-CT022



Material ABS

**SOPORTE DE CELULAR
PARA MOTO Y BICICLETA**

Cod. JV-K355-2



**SOPORTE PARA CELULAR
Y TABLET ESCRITORIO
GRADUABLE**

Cod. JV-L-316



**SOPORTE BRAZO
PARA CELULAR Y
TABLET 360°**

Cod. JV-ST002



**EXTENSIÓN 1X1
ESTÉREO BLANCA
1 METRO LS-Y02**

Cod. JV-LS-Y02



**CABLE AUDIO 1X1
ESTEREO ESPIRAL**

plug 3.5mm a plug 3.5 mm.
llamado cable auxiliar.

Cod. JV-1X1-ESPIRAL



Tipo C

1 metro



CABLE DE DATOS TIPO C DE 1 METRO

Cod. JV-MD-B018



CABLE MHL PARA IPHONE 1 METRO

Cod. JV-MHL-1M



CABLE DE DATOS CARGA RÁPIDA 3A TIPO C ESPIRAL DE 1.2 METRO

Cod. JV-MD-A58



Tipo LIGHTNING

1.5 metros



CABLE DE DATOS TIPO IPHONE A TIPO C 20W 1.5 METRO PD

Cod. JV-MD-A38



Tipo C

1 metro



CABLE DE DATOS TIPO C CARGA RAPIDA 2.4A

Cod. JV-MD-B008C



Tipo LIGHTNING

1 metro



CABLE DE DATOS TIPO IPHONE SILICONADO 3A 1 METRO

Cod. JV-MD-A65



Tipo LIGHTNING

1 metro



**CABLE DE DATOS IOS
CARGA RAPIDA 2.4A
SILICONADO**

Cod. JV-MD-B010IP



Tipo C

1 metro



**CABLE DE DATOS TIPO C
CARGA RAPIDA 2.4A
SILICONADO**

Cod. JV-MD-B010C



1 metro



**CABLE DE DATOS MICRO
CARGA RAPIDA 2.4A
SILICONADO**

Cod. JV-MD-B010



Tipo C

2 metros



**CABLE DE DATOS TIPO C
CARGA RAPIDA 3A 2METRO
SILICONADO**

Cod. JV-MD-A20C



Tipo LIGHTNING

2 metros



**CABLE DE DATOS
TIPO LIGHTNING
CARGA RAPIDA 3A 2M
SILICONADO**

Cod. JV-MD-A20IP



Tipo C

1.2 metro



**CABLE DE DATOS TIPO C 1.2
METRO YANPO
3.1A SOPORTA QC 3.0**

Cod. JV-DTY2

1.5 metros



CABLE DE DATOS DE NYLON TIPO C A TIPO C DE 1.5 METRO

Cod. JV-MD-B025

1.5 metros



CABLE DE DATOS TIPO C A IPHONE SILICONADO DE 1.5 METRO

Cod. JV-MD-A73

1 metros



CARGADOR TIPO C Q3.0 CON CABLE 1 METRO YANPO

Cod. JV-QC3-0

1.5 metros



CARGADOR USB (1) PUERTO M117 5V 2.1A

Cod. JV-M117

1.5 metros



CABLE DE DATOS TIPO C A TIPO C SILICONADO DE 1.5 METRO 60W

Cod. JV- MD-A72

2 metros



CABLE DE DATOS TIPO LIGHTNING CARGA RAPIDA 3A 2METRO

Cod. JV-MD-IPA20



**CABLE DE DATOS TIPO C
3A CARGA RÁPIDA 2M**



Tipo C
2 metros

Cod. JV-MD-A18C



**CABLE DE DATOS TIPO
IPHONE 3A CARGA
RÁPIDA 2M**



Tipo LIGHTNING
2 metros

Cod. JV-MD-IPA18



**CABLE DE DATOS TIPO
C 3A NYLON CARGA
RÁPIDA 1M**



Tipo C
1 metro

Cod. JV-MD-A66C



**CABLE DE DATOS TIPO C 3A
SILICONADO ALTA CALIDAD
CARGA RÁPIDA 2M**



Tipo C
2 metros

Cod. JV-MD-B013C



**CABLE DE DATOS TIPO C A C
5A PD NYLON ALTA CALIDAD
CARGA RÁPIDA 1.2M 60W**



Tipo C
1.2 metros

Cod. JV-MD-A70C



**CABLE DE DATOS TIPO C A
LIGHTNING 5A PD NYLON
ALTA CALIDAD CARGA
RÁPIDA 1.2M 20W**



Tipo C a LIGHTNING
1.2 metros

Cod. JV-MD-A69C

-19%

✓ Llegó



**CABLE TIPO C A TIPO C
90CM DE LONGITUD**

Cod. JV-CTOC



**MINI POWER BANK CARGA
RAPIDA
10.000 MAH MEIDOU**

Cod. JV-MD-P22



**CARGADOR PARA
CELULAR
TIPO C 2.4A QC3.0
CON CABLE DE DATOS**

Cod. JV-MD-C02C



**CARGADOR PARA CELULAR
CABLE MICRO 2.4A QC3.0
CON CABLE DE DATOS**

Cod. JV-MD-MC02



**CABLE DE NYLON
1X1 3.5MM 2M**

Cod. JV-MD-T011



**CARGADOR CELULAR PARA
CARRO USB+PD 3.4A**

Cod. JV-MD-D011



↔
DISTANCIA
10 METROS



EARPHONE
25mAh

**AUDIFONOS BLUETOOTH
RECARGABLES WATER PROOF
(IPX4) CON DISPLAY**

Cod. JV-MX-TW17



↔
DISTANCIA
10 METROS



EARPHONE
25mAh



**AUDIFONOS BLUETOOTH 5.3
RECARGABLES CON
DISPLAY**

Cod. JV-MX-TW51



**CARGADOR USB 2 PUERTO
CARGA RAPIDA 2.4A + 3A
C/MICRO LDNIO**

tecnología qualcom 3.0.
detecta el tipo de celular

Cod. JV-A2502QC



CARGADOR CARGA RÁPIDA 3A
PARA CARRO METÁLICO USB
+1PD

Cod. JV-MD-D008



CARGADOR PARA CARRO
3,1A - 2 USB

Cod. JV-CARX2



CONTROLES REMOTOS PARA TELEVISORES



En YANPO sabemos que el control remoto es un artículo muy común de perder y se avería fácilmente. Aquí puedes encontrar gran variedad de controles remoto a precios asequibles y de excelente calidad.

Nuestros controles son en ABS de alta calidad y cuentan con garantía de 6 meses por daños de fábrica.

CONTROLES REMOTOS PARA TELEVISORES

UNIVERSALES
VARIADOS DISEÑOS



Imagen de Referencia

CONTROL TV PANASONIC
(TV ANTIGUO)

Cod. JV-RM-986M



CONTROL REMOTO PARA
TV SAMSUNG LCD

Cod. JV-L1088V



-7%



CONTROL REMOTO PARA TV LG
L1379V

Cod. JV-L1379V



CONTROL REMOTO DVB-T2 -
TDT Y TV UNIVERSAL

Cod. JV-CRC-1155V

CONTROLES REMOTOS PARA TELEVISORES

UNIVERSALES
VARIADOS DISEÑOS



UNIVERSAL PARA TV LCD
CRC1130V(PBOX)

Cod. JV-CRC1130V



CONTROL REMOTO PARA TV
LCD PANASONIC L1268V

Cod. JV-L1268V



PARA TV SAMSUNG IR-
1316(WINBOX) DELGADO

Cod. JV-IR-1316



CONTROL REMOTO MR-20/19
MAGIC REMOTE

Cod. JV-MR-20-19



CONTROL REMOTO PARA
TV LCD SONY L1370V

Cod. JV-L1370V



A person's hand is shown holding a small amount of seeds or grains above a kitchen scale. The entire image is tinted green and features a repeating pattern of various vegetables like tomatoes, onions, and carrots in the background.

YANPO[®]
ELECTRONIC TECHNOLOGY

VARIEDADES

AMARRAS



**AMARRA 3X150MM
(500 PCS)**

Cod. JV-TIE3X150

**AMARRA 4X150MM
(300 PCS)**

Cod. JV-TIE4X150

**AMARRA 4X250MM
(150 PCS)**

Cod. JV-TIE4X250

**AMARRA 4X300MM
(150 PCS)**

Cod. JV-TIE4X300

**AMARRA 4X200MM
(300 PCS)**

Cod. JV-TIE4X200

BOMBA PARA FUENTE

BOMBA PARA FUENTE



Power: 2.5W
Qmax: 200 L/H
Alt max. 45 cm
IPX8

Cod: **JV-FS003**

BOMBA PARA FUENTE



Power: 3W
Qmax: 200 L/H
Alt max. 55 cm
IPX8

Cod: **JV-FS004**

BOMBA PARA FUENTE



Power: 4W
Qmax: 260 L/H
Alt max. 70 cm
IPX8

Cod: **JV-FS007**

BOMBA PARA FUENTE



Power: 10W
Qmax: 600 L/H
Alt max. 1,2 m
IPX8

Cod: **JV-FS008**

BOMBA PARA FUENTE



Power: 16W
Qmax: 750 L/H
Alt max. 1,5 m
IPX8

Cod: **JV-FS015**

BOMBA PARA FUENTE



Power: 21W
Qmax: 1200 L/H
Alt max. 2.0 m
IPX8

Cod: **JV-FS021**

BOMBA PARA FUENTE



Power: 45W
Qmax: 3000 L/H
Alt max. 3,0 m
IPX8

Cod: JV-FS060



BOMBA PARA FUENTE



Power: 80W
Qmax: 4000 L/H
Alt max. 4,0 m
IPX8

Cod: JV-FS095

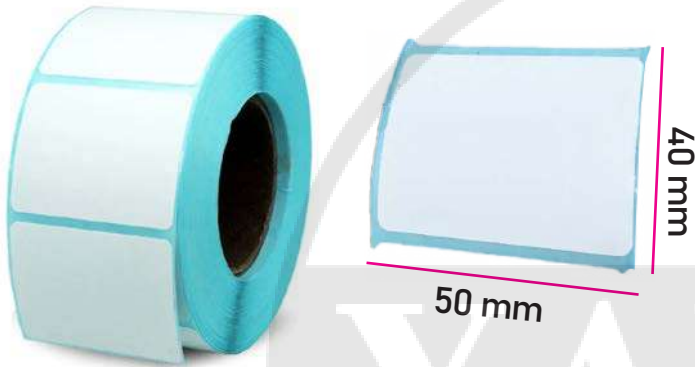

ROLLO DE PAPEL 50 X 40MM * 800 UNDS

Cod. JV-SK50X40

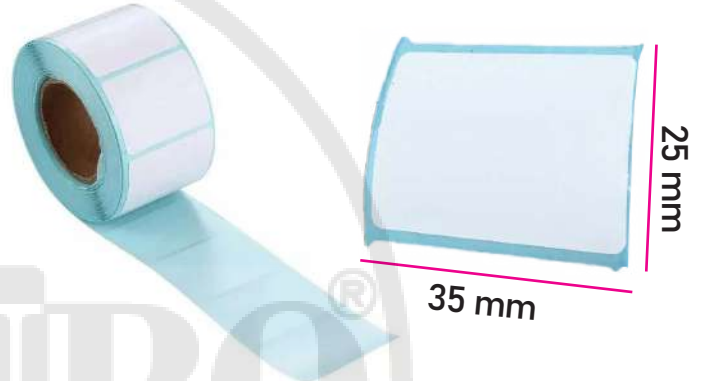

ROLLO DE PAPEL 35 X 25MM * 800 UNDS

Cod. JV-SK32X25



STICKER PARA IMPRESORA TERMICA
32MM X 25MM * 5000 UNDS

Cod. JV-32x25



STICKER PARA IMPRESORA
TERMICA 100MMX100MM

Cod. JV-100x100



**BASCULA DE BOLSILLO
200G/0.01G**

Cod. JV-SC200G



**BASCULA DE BOLSILLO
500G/0.1G**

Cod. JV-SC500G

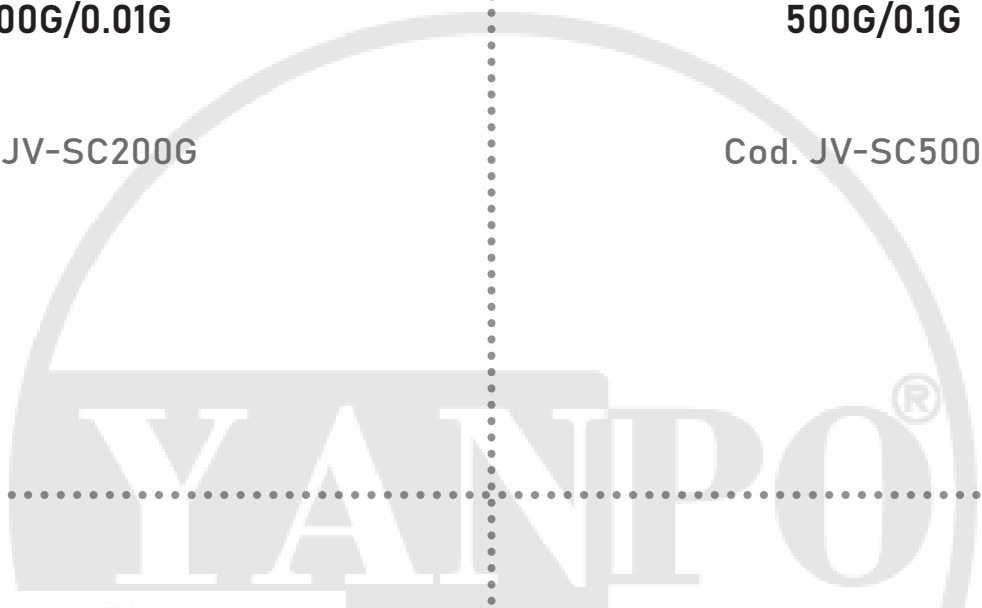

**NO INCLUYE
BATERIAS**

BASCULA ELECTRONICA PARA COCINA

Cod. JV-SF-400



**NO INCLUYE
BATERIAS**

**BASCULA ELECTRONICA PARA COCINA
CON RECIPIENTE**

Cod. JV-B05



DISPENSADOR AUTOMÁTICO DE AGUA PARA BOTELLÓN RECARGABLE

Cod. JV-DW



RESISTENCIA PARA SELLADORA

Cod. JV-RT200



SELLADORA DE MANO 200MM

Máquina selladora térmica con
cuerpo de hierro.

Cod. JV-FS-200





BOLSA PARA ENVIOS

el interior revestido de plástico.
medidas: 13x15cm.

Cod. JV-BK1315



BOLSA PARA ENVIOS

el interior revestido de plástico.
medidas: 15x20cm.

Cod. JV-BK1520



BOLSA PARA ENVIOS

el interior revestido de plástico.
medidas: 18x18cm.

Cod. JV-BK1818



BOLSA PARA ENVIOS

el interior revestido de plástico.
medidas: 24x29cm.

Cod. JV-BK2429



BOLSA PARA ENVIOS

el interior revestido de plástico.
medidas: 26x30cm.

Cod. JV-BK2630

PERFECTO

Para enviar tus
productos bien
protegidos.



YANPO[®]
ELECTRONIC TECHNOLOGY



**MISCELANEA
ELECTRÓNICA**



**ESPUMA LIMPIADORA
MULTIUSOS 650ML**

Cod. JV-HB016



**MOTOR REDUCTOR 12V
TORQUE 1KG MTR1**

Cod. JV-49005

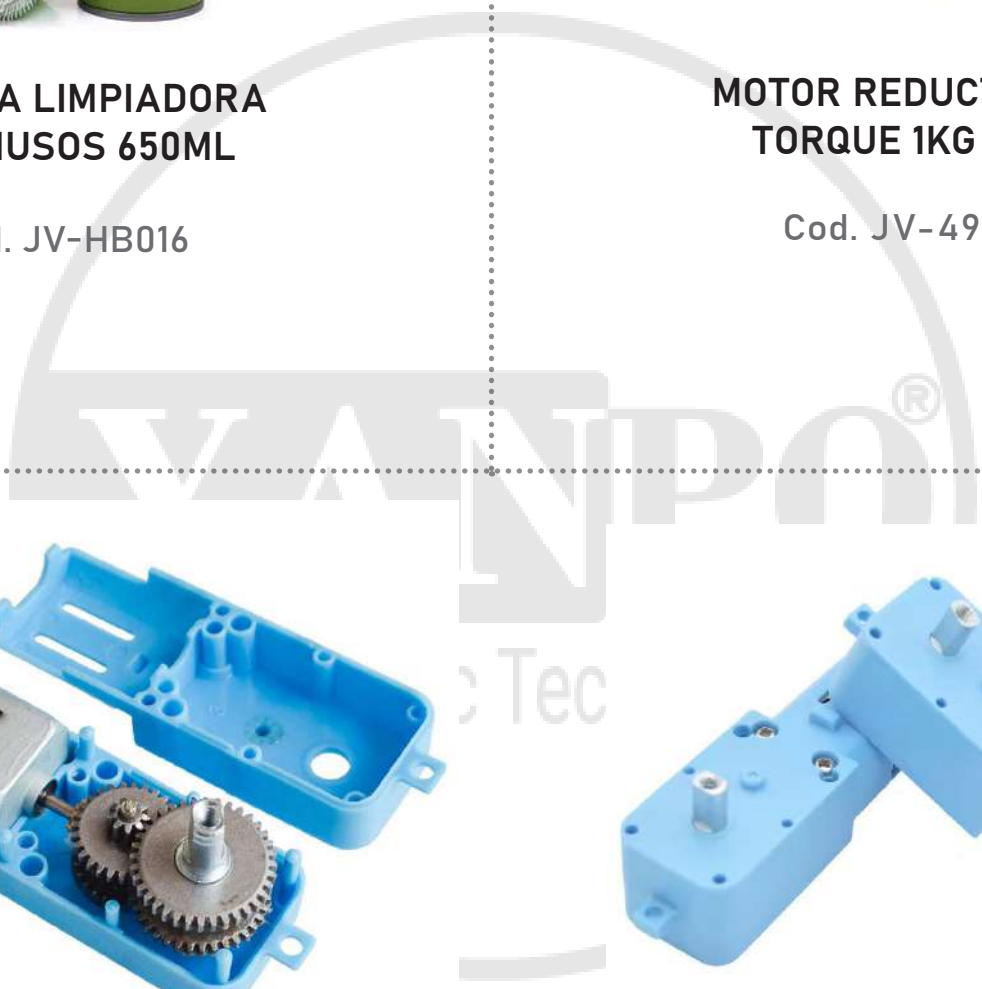

**MOTOREDUCTOR CON 2 EJES
METALICOS 4 ENGRANAJES METALICOS
TRANSMISION 1:90 COLOR AZUL**

Cod. ARD-MTB

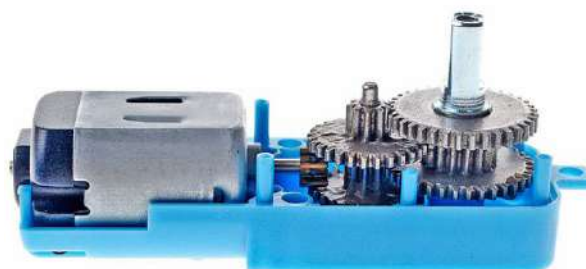



MOTOR PARA PROYECTO ESTUDIANTIL 3V-6V

Cod. JV-MT3V



MOTOR PARA PROYECTO ESTUDIANTIL 9V-12V

Cod. JV-MT9-12V



LLANTAS PARA PROYECTOS ESTUDIANTILES

Cod. JV-WH



MOTOR PARA PROYECTOS ESTUDIANTILES

Cod. JV-MTY



TECLADO MATRICIAL 1X4 DE MEMBRANA ARDUINO

Cod. 1004

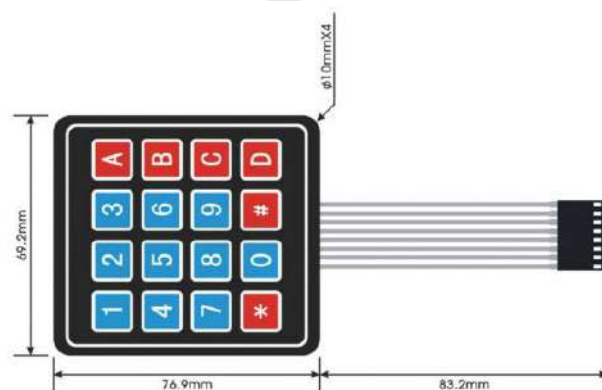

TECLADO 4X4 MATRIZ

Cod. 1008



CAIMAN CON CABLE 1M

Cod. JV-CAIMAN1M



PUNTAS PARA TESTER

Cod. JV-BPPM2

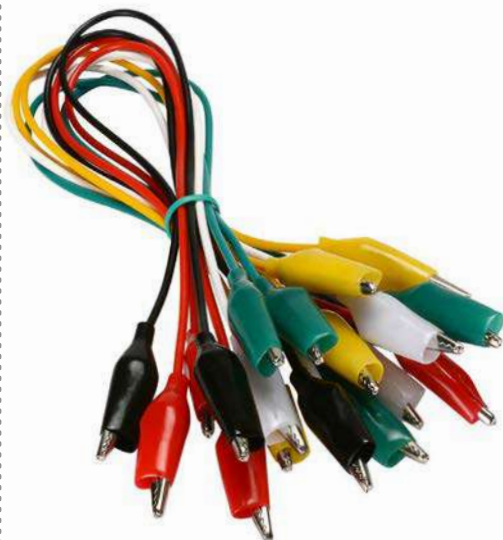

JUEGO DE 10 CAIMANES EN COLORES SURTIDOS

Cod. YP-CAMX10



PUNTAS PARA MULTIMETRO 10A

Cod. JV-PPM



PUNTAS BANANA PINZAS DE PRUEBA MULTÍMETRO CAIMAN

Cod. DGT-9227



PUNTAS MULTIMETRO, CON PUNTAS BANANA

Cod. DGT-9212



**PUNTAS PARA
MULTIMETRO**

Cod. DGT-9228



-12%

**MANILLA ANTIESTÁTICA
AZUL**

Cod. JV-152



PINZA DE PRECISIÓN

Cod. JV-TWZ



PINZA MULTIUSOS

Cod. JV-PZ



**SWITCH 2 POSICIONES,
6 PINES 30 AMP 250V 30
AMP 125V CON PILOTO.**

Cod. YP-CN26C



**INTERRUPTOR DOBLE
FLASH Y SWITCH 5 AH**

Cod. YP-IDF5A

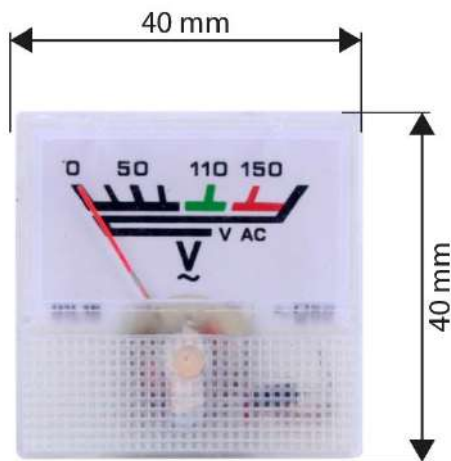

**VOLTÍMETRO ANALÓGICO
PARA PANEL 0-150V AC**

Cod. YP-VOLCO



**POSTE METÁLICO 5MM X
12MM
(SIN TUERCA)**

Cod. 43016



FOTOCELDA 12MM

Cod. 36001



AISLANTE GOMA TO-220

Cod. JV-GOMA220



**PANEL SOLAR 5V/100MA
72X58MM**

Cod. JV-PA-5V100A



**PANEL SOLAR 12V/100MA
110X90MM**

Cod. JV-12V100A-PA



**MICROSERVO PIÑONERIA
180° PLÁSTICA 4.8V**

Cod. SG90



**SERVOMOTOR MG90S EJE
METALICO 180° EJE METALICO,
TORQUE 2.2 KG**

Cod. ARD-MG90S

BAJÓ



**SERVOMOTOR S3003 - VOLTAJE:
4.8V~6V
TORQUE: (3.2~4.1) KG*CM**

Cod. S3003



**SERVOMOTOR TOWER PRO
SG5010 - 6KG.**

Cod. SG5010

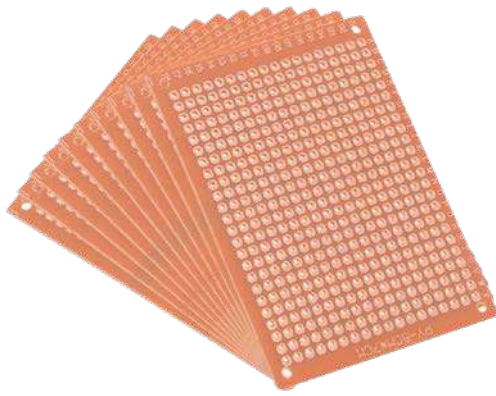

**IMPRESO UNIVERSAL PUNTO
5X7CM**

Cod. 43003



**IMPRESO UNIVERSAL PISTA DIAM
4.5 X 7CM**

Cod. 43001

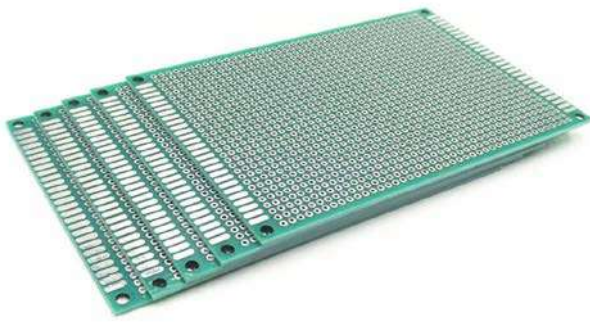

**IMPRESO UNIVERSAL
DE PUNTOS 9X15CM**

Cod. JV-9X15-P



**BAQUELA VIRGEN
DOBLE CARA 10X7 CM**

Cod. BAQ-DCV710



BROCHE PILA 9V

Cod. 55001



**ADAPTADOR PLUG JACK MACHO
PILA BATERIA 9V 5.5*2.5MM**

Cod. JV-9V55X25



CELDA PELTIER

Celda peltier tec-12-706 12V-92W

Cod. 36005



REGLETA (1X40)

Cod. 26009



REGLETA MACHO (1X40) 90°, 2.54MM

Cod. JV-26080



REGLETA HEADER 1X40 HEMBRA

Cod. 26011

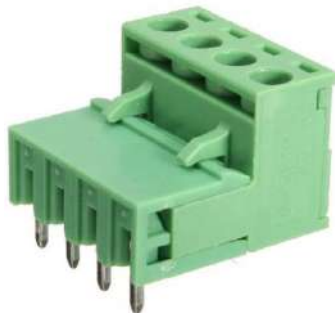

BORNERA DESARMABLE 4 PINES 5MM

1 Hembra x 2 macho.
Cable fino tipo cordón.

Cod. JV-8008

16 mm



MÓDULO LCD 2X16 FONDO AZUL

Cod. JV-47007

2 mm



PORTAFUSIBLE CHASIS 6X30 MM

Cod. PF-1

5 mm

20 mm

PORTAFUSIBLE CHASIS 5X20MM

Cod. PF-2



PORTA FUSIBLE EXTERNO 5X20

Cod. JV-PFEX5X20

-37%

Llegó



PORTA FUSIBLE EXTERNO 6X30

Cod. JV-PFEX6X30

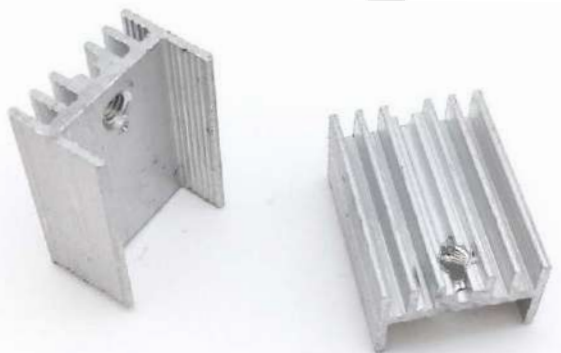

DISIPADOR ALUMINIO

T0220

Cod. 30014



BORNERA C PARA CÁMARA
MACHO Y HEMBRA (pareja)

Cod. BORNERA-DC



PROTOBOARD MINI EN COLOR BLANCO

- 170 Puntos
- Con adhesivo

Cod. MINI-QTC

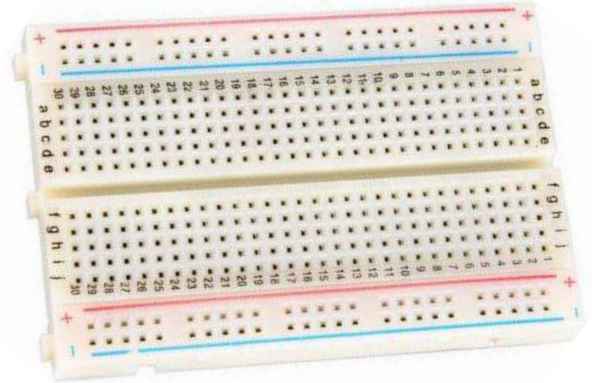

PROTOBOARD PEQUEÑA BLISTER

- 400 Puntos

Cod. WB-100

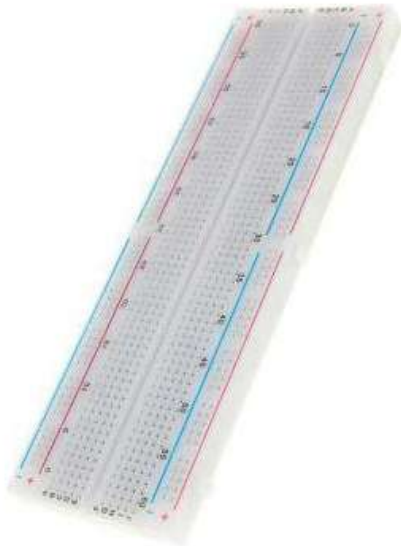
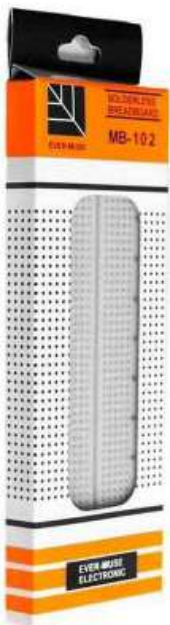

PROTOBOARD 2 BUSES

- 830 Puntos

Cod. MB-102

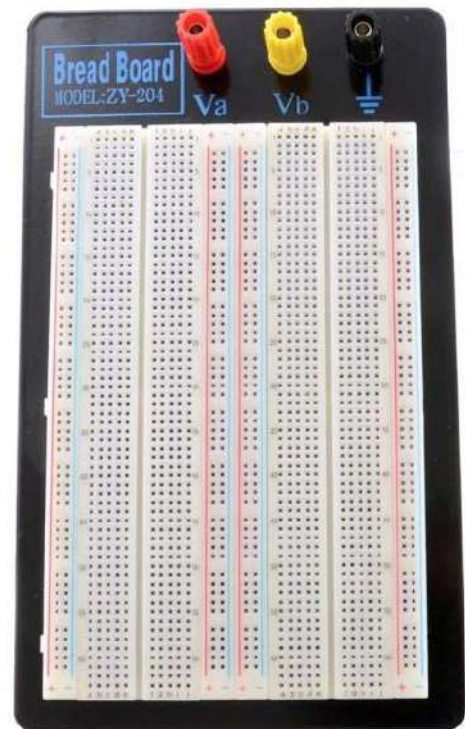

PROTOBOARD 4 BUSES

1660 PUNTOS

Cod. ZY-1660

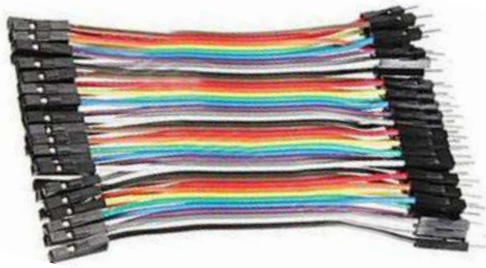

**CABLE JUMPER 10 CM
MACHO - HEMBRA 40 PINES**

Cod. JUMPER-10MH



**CABLE JUMPER 20 CM
MACHO - HEMBRA 40 PINES**

Cod. JUMPER-20MH



**JUMPER 10CM (40 PINES)
MACHO-MACHO**

Cod. JUMPER-10MM



-6%



**JUMPER 20CM (40 PINES)
MACHO-MACHO**

Cod. JUMPER-20MM



**JUMPER 10 CM (40 PINES)
HEMBRA - HEMBRA**

Cod. JUMPER-10HH



-8%



**JUMPER 20CM (40 PINES)
HEMBRA-HEMBRA**

Cod. JUMPER-20HH



IMAN NEODIMIO CIRCULAR 8X5MM

Cod: JV-8X5



IMAN NEODIMIO CIRCULAR 12X2MM

Cod: JV-12X2

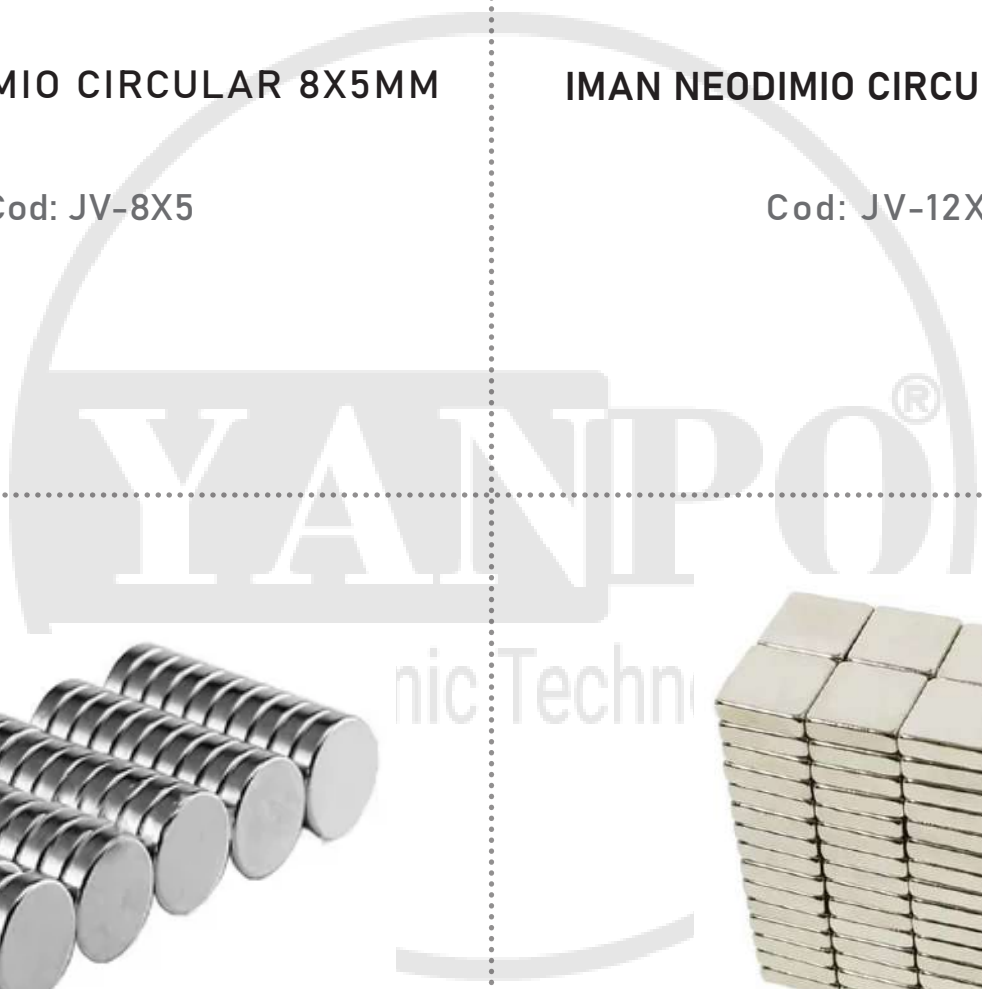

IMAN NEODIMIO CIRCULAR 12X3MM

Cod: JV-12X3



**IMÁN NEODIMIO CUADRADO
10 X 10 X 2 MM**

Cod. JV-10X10X2



**IMAN NEODIMIO CIRCULAR
15X3MM**

Cod: JV-15X3



**IMAN NEODIMIO CIRCULAR
18X1.6MM**

Cod: JV-18X2



IMAN NEODIMIO CIRCULAR 18X2.5MM

Cod: JV-18X3



IMAN NEODIMIO CIRCULAR 25X2MM

Cod: JV-25X2

Electronic Technology

CONDENSADORES O FILTROS ELECTROLÍTICOS



FILTROS DE 16 VOLTIOS

MF X VOLTIOS	PRECIO
47uF/16v	

FILTROS DE 50 VOLTIOS

mF x Voltios	PRECIO
4,7uF/50v	



YANPO[®]
ELECTRONIC TECHNOLOGY

MODULOS ARDUINOS

PROGRAMADORES

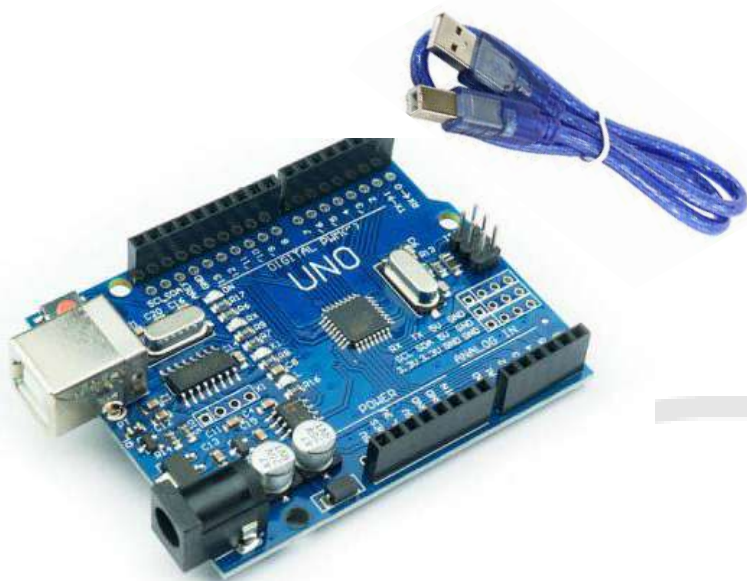

**ARDUINO UNO R3 CHIP SUPERFICIAL
CON CABLE**

Cod. ARD-SUP-UNO

-26%



**ARDUINO UNO R3 ORIGINAL
CON CABLE**

Cod. ARD1-ORIG

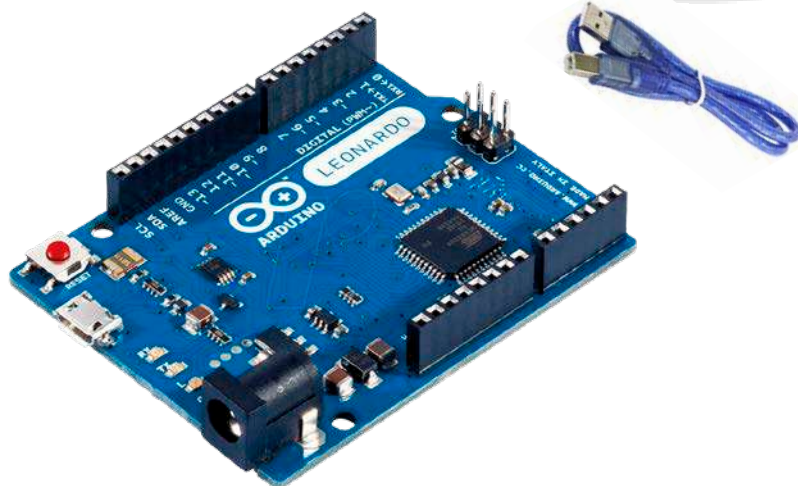

**ARDUINO LEONARDO
CON CABLE**

Cod. ARD-LEO

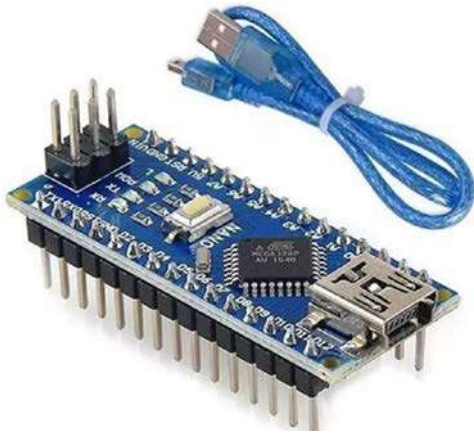

ARDUINO NANO CH340 MINI USB CON CABLE

Cod. ARD-NANO340

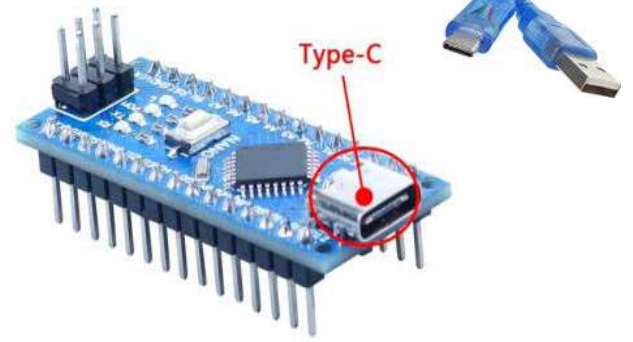

ARDUINO NANO TIPO C CON CABLE

Cod. ARD-TCNANO

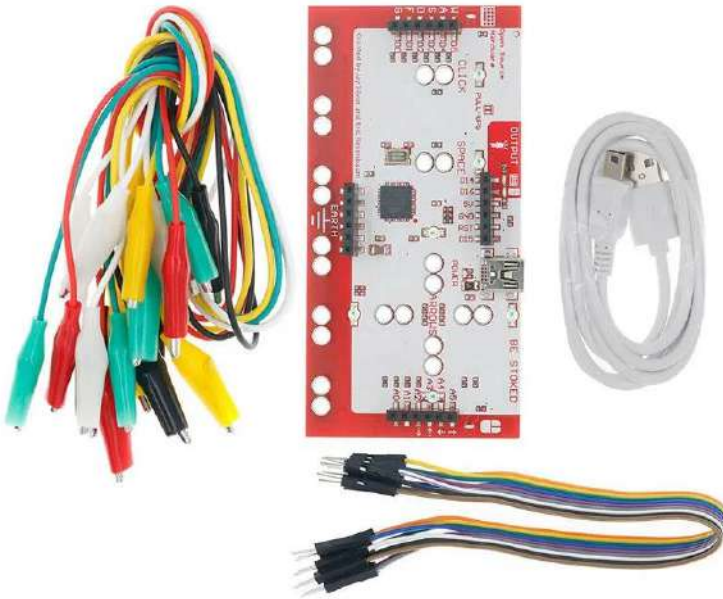

KIT: TARJETA MAKEY MAKEY,

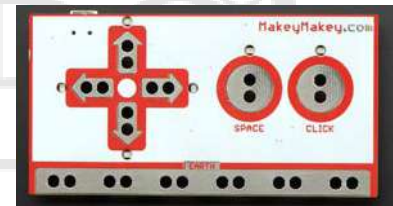

10 CABLES CAIMÁN,
CABLES CONECTORES,
1 CABLES USB

Cod. JV-MAKEY



ARDUINO MEGA 2560

PLACA DE DESARROLLO MEGA 2560
R3 COMPATIBLE CON ARDUINO ES UN
MICROCONTROLADOR BASADO EN EL
ATMEGA2560.

- INCLUYE CABLE -

Cod. ARD-MEGA2560

KIT DE INICIO PARA EL DESARROLLO UNO R3

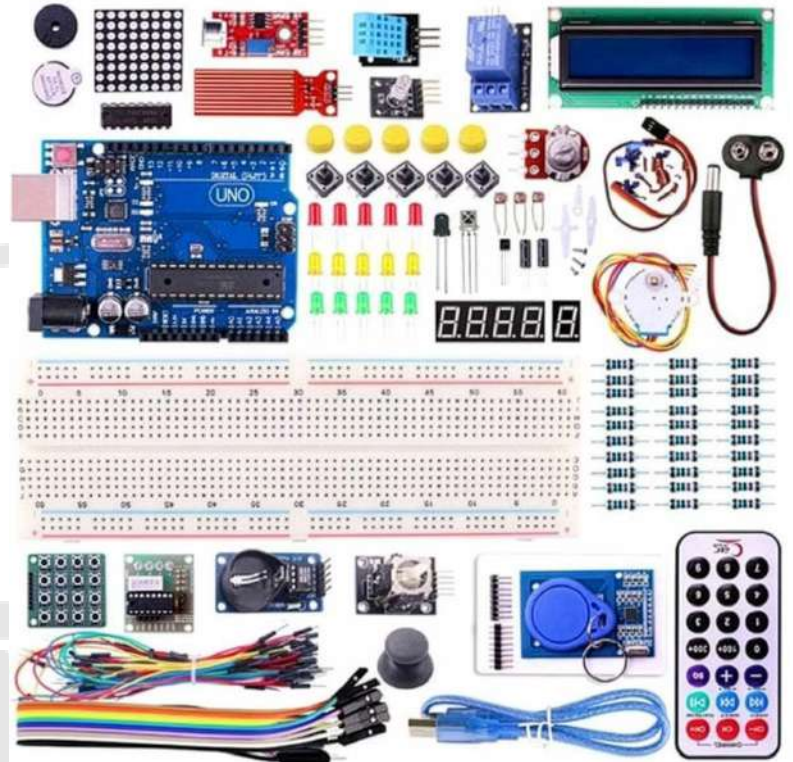

Cod. ARD-KIT200

- 1x Arduino UNO R3.
- 1x Cable USB al módulo base.
- 1x LCD1602 IIC i2c: pantalla en bus I2C con retroiluminación azul. Puede apagar la retroiluminación quitando el puente.
- 1x Módulo RC552: lector RFID de 13,56 MHz con antena incorporada que contiene todo lo necesario para su fácil uso.
- 1x Tarjeta RFID blanca.
- 1x Colgante/llavero RFID azul.
- 1x Módulo joystick.
- 1x Teclado 4x4 (16 botones).
- 1x Módulo RTC: módulo I²C (RTC) preciso en tiempo real con oscilador de cristal con compensación de temperatura integrado.
- 1x Sensor de nivel de agua Arduino.
- 1x Sensor de humedad Arduino.
- 1x Módulo LED RGB.
- 1x Módulo de control de motor paso a paso.
- 1x Motor paso a paso de 5 V - 28BYJ-48.
- 1x Módulo de relé de 1 canal de 5 V, 250 V CA 10 A/30 V CC 10 A.

- 1x Protoboard MB-102 (830 pines).
- 30x Cables jumper macho-macho (diferentes medidas).
- 10x Cable jumper macho-hembra (20cm).
- 1x Sensor de sonido Arduino.
- 1x Control remoto IR.
- 1x Potenciómetro de 10 K
- 1x Dígito digital (12 × 19 mm).
- 1x Dígito digital de 4 (50 × 19 mm).
- 1x Matriz LED de 8x8 (32 x 32 mm)
- 1x Micro servo 9G (SG90)
- 2x Buzzers
- 2x Sensores de impacto SW-520D
- 3x Fotorresistencias
- 5x Interruptores de botón
- 1x Conector para batería de 9 V
- 30x LED (10 verdes, 10 rojos, 10 amarillos)
- 30x Resistencias (220R, 10K, 1K)
- 1x Indicador de llama.
- 1x 74HC595N.
- 1x Receptor de infrarrojos.
- 1x Sensor de temperatura LM35DZ.
- 1x Regleta (1X40).

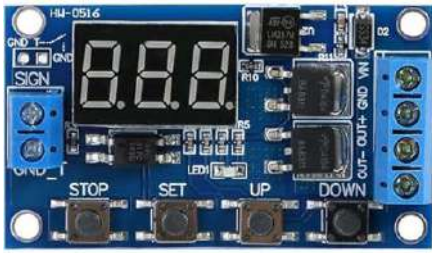

**MODULO
TEMPORIZADOR
CON
PULSADORES**

Cod. ARD-MTEM



**TERMOCUPLA
TIPO K CONTROL
TEMPERATURA**

Cod. ARD-TMCAK



**MODULO RECEPTOR
RADIO FM - TEA5767
CON ANTENA -
ARDUINO**

Cod. ARD-FM5767



**REGULADOR FUENTE
PROTOBOARD DUAL
3.3-5V PLUG MODULO
ARDUINO**

Cod. ARD-RFPD

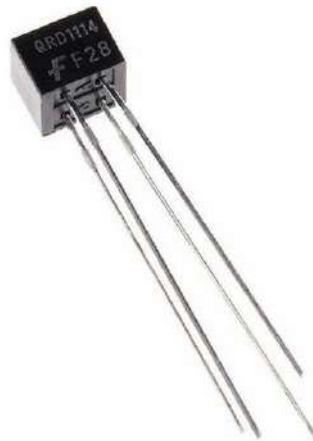

SENSOR QRD1114

Cod. QRD1114



**CABLE 2 CAIMANES
X2 CONECTORES DE
PRUEBA 1MT**

Cod. ARD-CAXPR1M

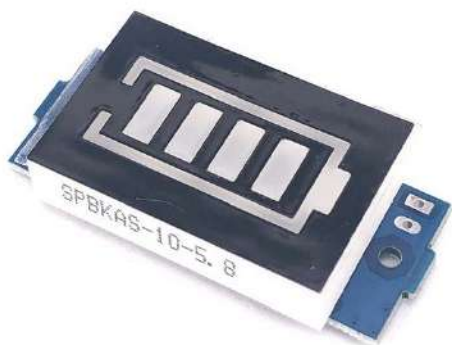

**MODULO INDICADOR
CARGA BATERIA BS-10**

Cod. ARD-BS-10

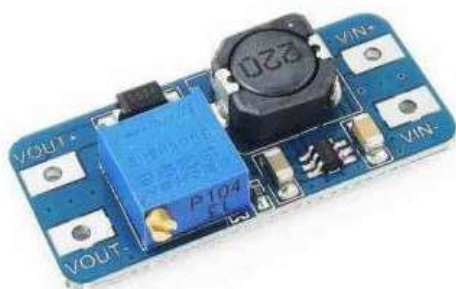

**MODULO ELEVADOR
BOOSTER MT3608**

Cod. ARD-MT3608



**MODULO AMPLIFICADOR
AUDIO XPT8871**

Cod. ARD-XPT8871



**MODULO DE VENTILADOR
L9110**

Cod. ARD-MVENT



MODULO LED RGB 5MM

Cod. ARD-MRGB

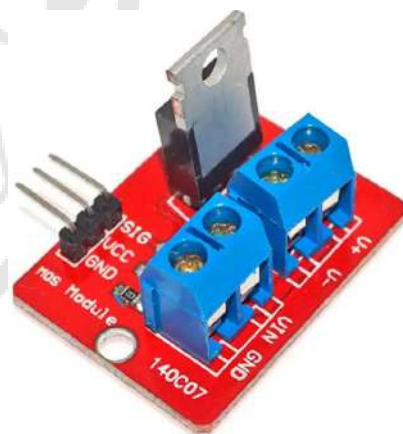

**MODULO MOSFET IRF520
5A DRIVER, PWM,
ARDUINO**

Cod. ARD-IRF520



**MÓDULO DE PANTALLA
TM1637, 7 SEGMENTOS,
4 DÍGITOS, ARDUINO DIY
LED**

Cod. ARD-TM1637-4

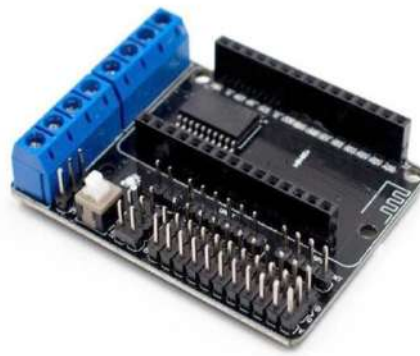

**MODULO SHIELD
NODEMCU L293D**

Cod. ARD-NDL293D



**MODULO JACK
ALIMENTACIÓN CIRCUITO
- ARDUINO**

Cod. ARD-MJA



**MODULO
TEMPORIZADOR 1 RELE
5V BUZZER**

Cod. ARD-MT1R

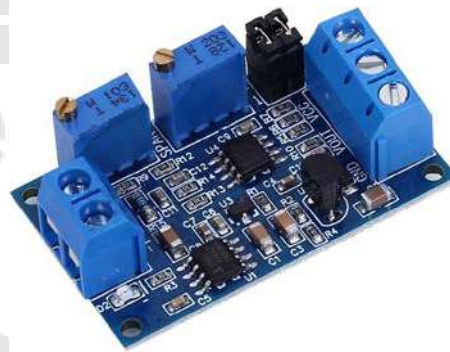

**MODULO CONVERTIDOR
CORRIENTE A VOLTAJE
4-20MA / 2-24V**

Cod. ARD-MCC20MA



**STEPDOWN POWER
MÓDULO DC-DC
AJUSTABLE CON PANTALLA
LED 1.3- 37V**

Cod. ARD-MLM2596



MODULO JOYSTICK CON BOTONES

Cod. ARD-JYK

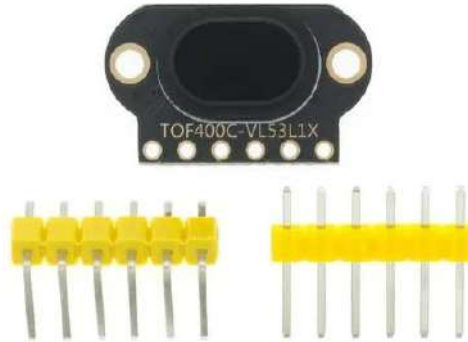

**MODULO VL53L1X
LASER MEDIDOR
DISTANCIA 0-400CM**

Cod. ARD-VL53L1X

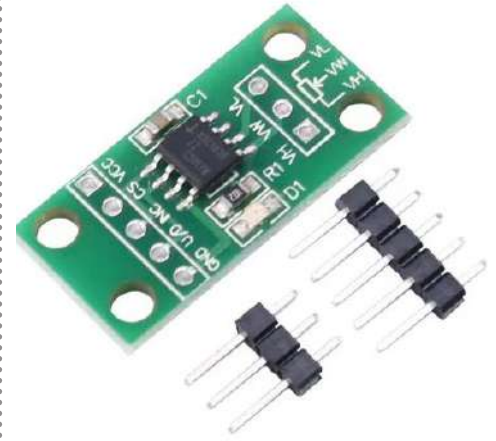

**MODULO POTENCIOMETRO
DIGITAL X9C103S 10K 3V-
5V XDCP ARDUINO**

Cod. ARD-MPDX9



**MODULO DISPLAY X8
DIGITOS**

Cod. ARD-MDPX8

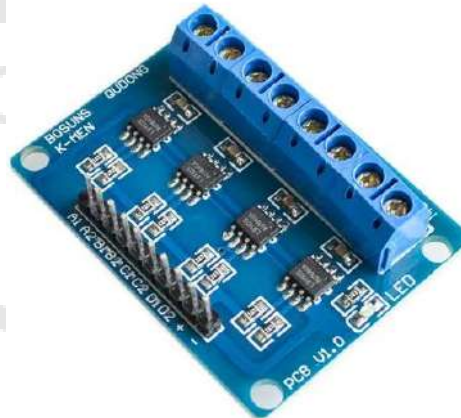

**MODULO PUENTE H
DRIVER L9110S 4 CANALES
COMPATIBLE ARDUINO**

Cod. ARD-MPH9110

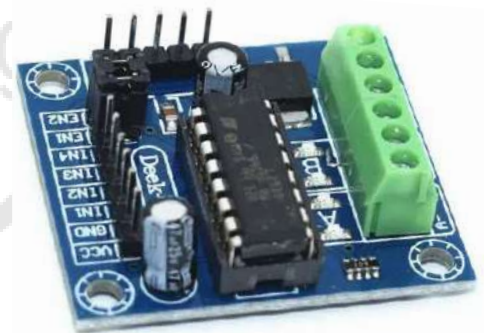

**MODULO L293D DE 4
CANALES DC4.5-25V 1.2A
ARDUINO**

Cod. ARD-4CHL293D



**MODULO BMS
HX-3S**

Cod. ARD-HX-3S

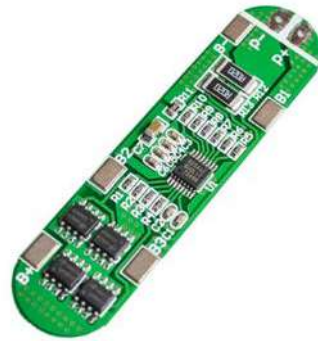

**MODULO BMS
HX-4S**

Cod. ARD-HX-4S

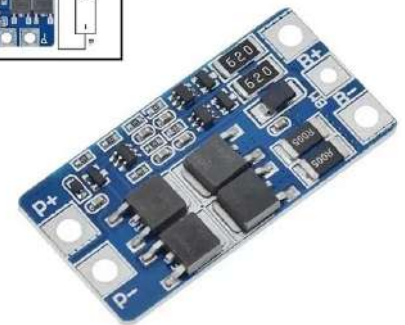
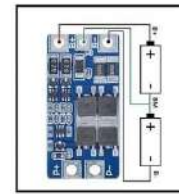

MODULO BMS HX-2S

Cod. ARD-HX-2S



**MODULO RELE
WIFI ESP-01S 5V
INTERRUPTOR
INALAMBRICO ARDUINO**

Cod. ARD-WIFICH1



**MODULO SENSOR
INFRARROJO DE
RASTREO DE 4 CANALES.**

Cod. ARD-MR4CH

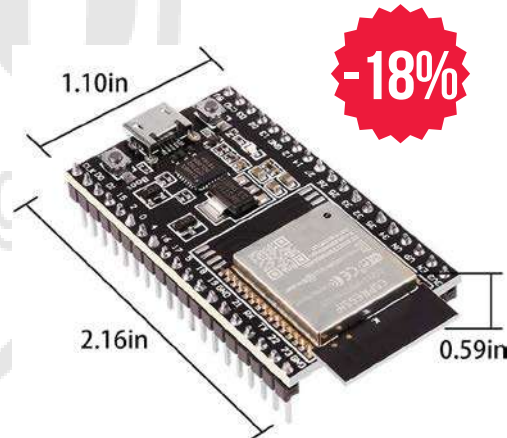

-18%

**PLACA DE DESARROLLO
IOT ESP32 - 38 PINES**

Cod. ARD-ESP32-38P



MODULO ARDUINO ELECTROCARDIOGRAMA

Cod. ARD-MECG



MULTIPLEXOR 16 CANALES ANALOGICOS CD74HC4067 ARDUINO

Cod. ARD-MTX16CH

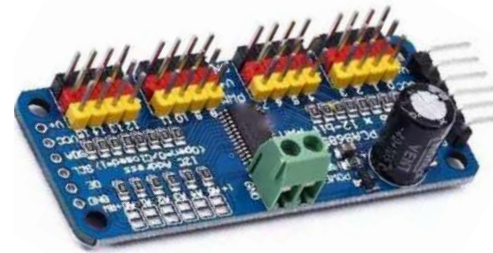

MODULO CONTROLADOR DE MOTOR CON 16 SALIDAS PWM SERVOMOTOR ARDUINO

Cod. ARD-M16S



MÓDULO CONTROLADOR DE MOTOR JV-L293D -4 MOTORES

Cod. L293D-MOTOR



MODULO CONVERTIDOR RS232 A TTL MAX3232

Cod. ARD-MRS232



MODULO CODIFICADOR ROTATIVO EC11 GIRATORIO + PERILLA ARDUINO

Cod. ARD-NC-EC11

-9%

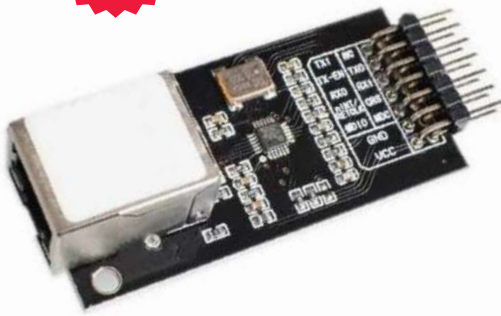

**MODULO ETHERNET
RED LAN**

Cod. ARD-METH

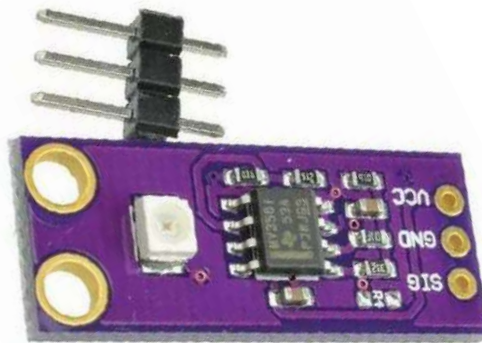

**SENSOR INTENSIDAD LUZ
ULTRAVIOLETA UV GUA-
S12S ARDUINO**

Cod. ARD-S12S



**MÓDULO RS-485 / TTL
A RS485**

Cod. ARD-MMAX485

YANIPPO®



**CONTROL REMOTO
INFRARROJO HX1838
VS1838**

Cod. ARD-HX1838



**SENSOR VELOCIDAD
ENCODER CON RUEDA
HC-020K 20PPR**

Cod. ARD-HC-020K



**VOLTIMETRO
AMPERIMETRO
10-100**

Cod. ARD-VOAMP

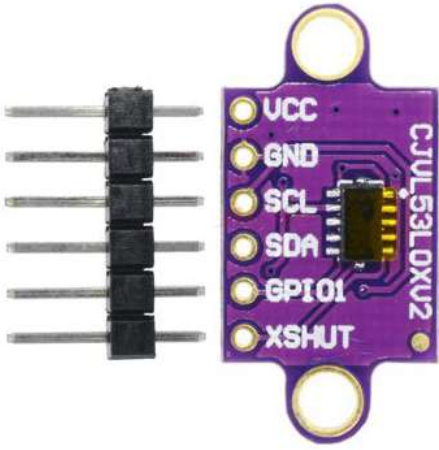

**SENSOR DE DISTANCIA
LASER VL53L0X GY
VL53L0XV2 ARDUINO**

Cod. ARD-VL53L0



vista posterior

**PLACA V2 TORNILLOS
BORNERA ARDUINO**

Cod. ARD-V2BORNERA

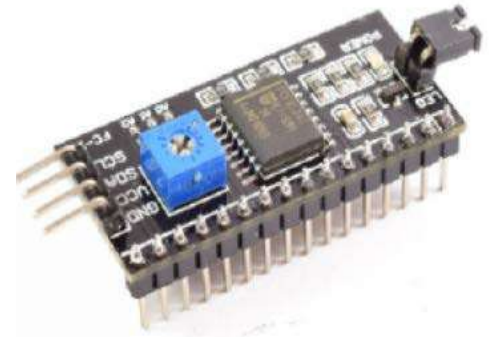

**MÓDULO I2C
ALFANUMÉRICO**

Cod. JV-ARD-I2C

YANIPPO[®]

Electronics Technology

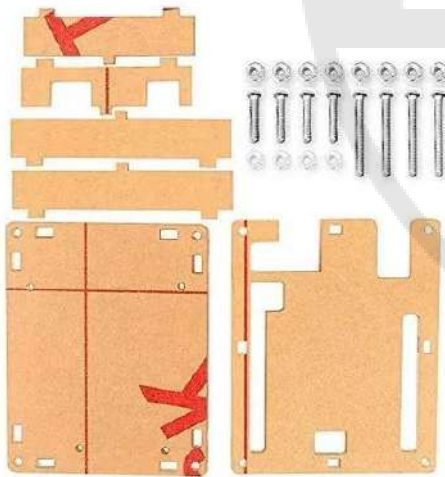

**CAJA PARA ARDUINO
UNO TRANSPARENTE**

Cod. JV-CJUNO

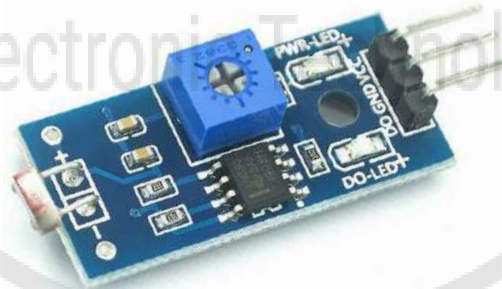

**MODULO SENSOR DE LUZ
LDR FOTOCELDA**

Cod. ARD-MSLUZ

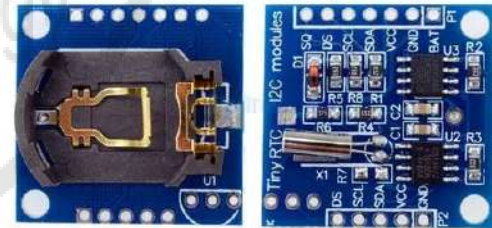

MÓDULO RELOJ DS1307

Cod. ARD-SDS1307



**PORTA PILA BATERIA -
(AA) X2 ARDUINO**

Cod. JV-PP2AA



**PORTA PILAS PARA 6
PILAS AA CON PLUG DC**

Cod. JV-PP6AA



**AMPLIFICADOR DIGITAL
TPA3118 PBTL BOARD
1X60W ARDUINO**

Cod. ARD-TPA3118

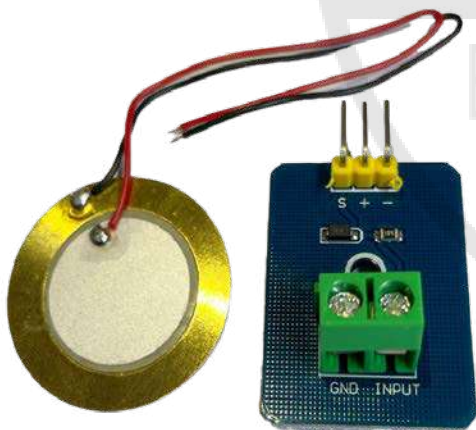

**SENSOR DE VIBRACIÓN
PIEZOELECTRICO
COMPATIBLE ARDUINO
ESP32**

Cod. ARD-VB32

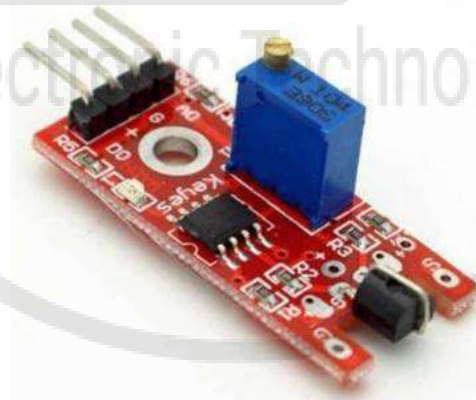

**MÓDULO EFECTO HALL
SENSOR DE CAMPO
MAGNETICO CON
GRADUACION KY-024 49E**

Cod. ARD-KY024

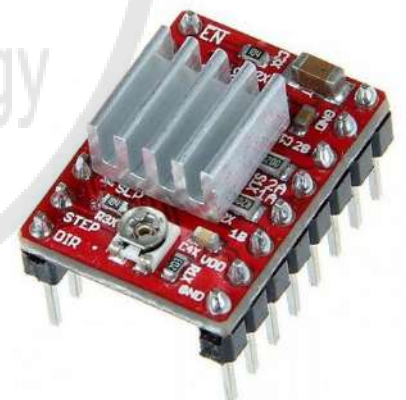

**MODULO MOTOR PASO
A PASO A4988**

Cod. ARD-MA4988



DISPLAY MATRIZ DE PUNTOS LED 8X8

Cod. ARD-7912



MINI BOMBA DE AGUA SUMERGIBLE 5V PROYECTOS ARDUINO

Cod. ARD-MB5V



MODULO CONVERTIDOR DC-DC ENTRADA 2 - 24 VOLTIOS SALIDA 5 - 28 VOLTIOS MÁXIMO 2AMP

Cod. ARD-MC25



SENSOR SWITCH DE NIVEL DE AGUA - VERTICAL

Cod. ARD-SNVAGUA



MÓDULO AMPLIFICADOR ENERGIA AUDIO

Cod. ARD-TDA7297



SENSOR DE NIVEL DE AGUA LIQUIDO FLOTADOR INTERRUPTOR

Cod. ARD-SFLOT



KIT CHASIS SMART CAR ROBOT ARDUINO

INCLUYE:

- Un (1) Chasis de carro en acrílico transparente.
- Dos (2) Motor de engranajes.
- Dos (2) Ruedas encoders de velocidad.
- Dos (2) Llantas.
- Una (1) Rueda loca.
- Un (1) KIT de Tornillos, tuercas y separadores metálico.

Cod. JV-2WD



MÓDULO CARRO INTELIGENTE 2 MOTORES 2 BASES DE CHASIS SEGUIDOR DE LINEA 240 RPM

Incluye:

- Chasis de coche en acrílico (2 placas + 4 soportes de motor).
- Dos (2) llantas traseras en goma semi dura.
- Dos (2) ruedas locas tipo rodachin en plástico abs de alta dureza.
- Dos (2) discos plásticos para función de tacómetro (no incluye fotodetectores o encoder).
- Un (1) porta-pilas de 2 pilas aa (no incluidas).
- Dos (2) motores de engranajes.
- Cuatro (4) postes metálicos roscados de 30 mm.
- Cuatro (4) tornillos de cabeza redonda de 30 mm.
- Ocho (8) espaciadores de tuerca m2.5 x 8mm.
- Catorce (14) tornillos m2.5 x 8mm de cabeza redonda.
- Catorce (14) tuercas.
- Dos (2) tornillos m2.5 x 8mm de cabeza plana.

Cod. JV-2M2B



**ARDUINO CLAVE RF-ID
AZUL (LLAVERO)**

Cod. ARD-RFID



**TARJETA CUADRADA
BLANCA RF-ID 522**

Cod. ARD-RFID522



**KIT RF-ID
(TARJETA, LECTORULO
ARDUINO)**

Cod. ARD-SETRFID



5 cm

**HELICE DE COLOR VERDE
CON MOTOR 3V-6V**

Cod. JV-HLMTV



7 cm

**HELICE DE COLOR
AMARILLO CON MOTOR
3V-6V**

Cod. JV-HLMTA



**MODULO ARDUINO
LM317T**

Cod. ARD-LM317T

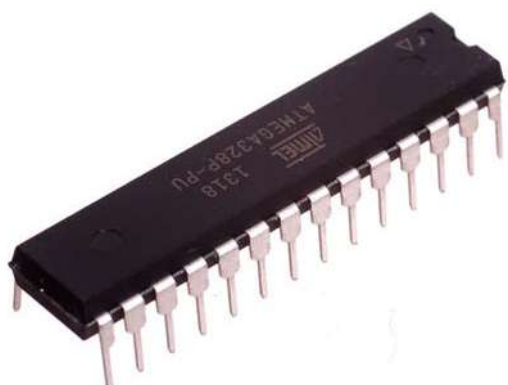

**MICROCONTROLADOR
ATMEGA 328P**

Cod. JV-AT328



MINI CÁMARA VGA

Cod. OV7670

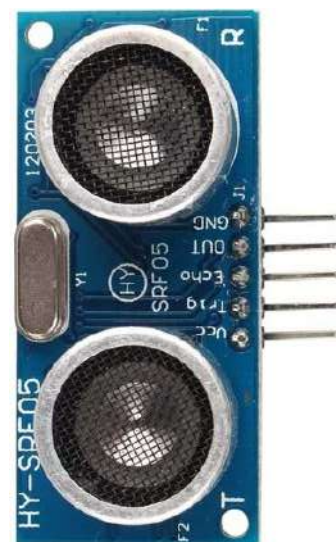

**MÓDULO ULTRASONIDO
ARDUINO HC-SRF05**

Cod. ARD-SRF05

-13%



**MÓDULO RF433
TRANSMISOR RECEPTOR**

Cod. MODULO-RF433

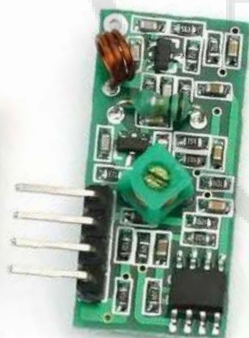

**MÓDULO RELE
1 CANAL**

Cod. ARD-MCH1



**MÓDULO RELE
2 CANALES**

Cod. ARD-MCH2



MÓDULO RELE 4 CANALES ARDUINO

Cod. ARD-MCH4



MÓDULO RELE 8 CANALES

Cod. ARD-MCH8



SENSOR OPTICO DE 4 CANALES DE RASTREO

Cod. JV-SL4CH



CELDA DE CARGA 50KG

Cod. ARD-C50KG

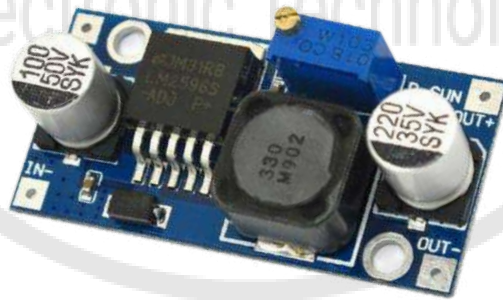

MÓDULO LM2596 CONVERTIDOR

Cod. ARD-MC2596

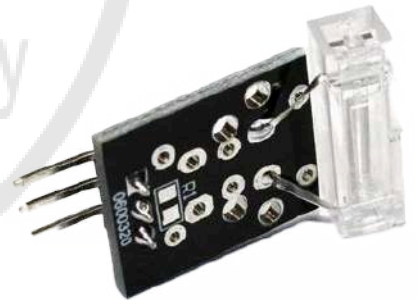

SENSOR DE GOLPE KY - 031

Cod. ARD-KY-031



**SENSOR LLAMA
MÚLTIPLE 5 CANALES**

Cod. ARD-LLAMA-5



**SENSOR TÁCTIL DIGITAL
TOUCH ARDUINO**

Cod. ARD-ST



**MINI ALTAVOZ 4 OHM 3W
ARDUINO
(PRECIO UNITARIO)**

Cod. ARD-P4-3W



**SENSOR TIPO HERRADURA
ITR9608**

Cod. KLH512L



**MÓDULO DETECTOR DE
OBSTÁCULOS**

Cod. ARD-DTOB6



**SENSOR EFECTO HALL
3 PINES PLATE.**

Cod. ARD-SHALL

-13%

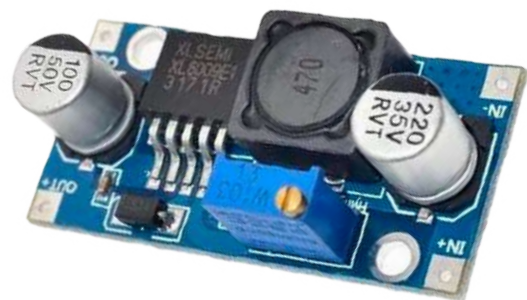

**MÓDULO FUENTE
ELEVADORA DC 5-32V**

Cod. ARD-XL6009



**SENSOR INFRAROJO DE
OBSTÁCULOS**

Cod. ARD-KY032



**MÓDULO
ACELERÓMETRO
ADXL335**

Cod. ARD-MA335

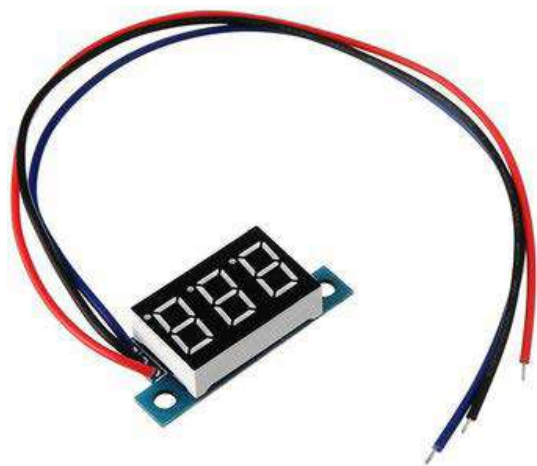

**VOLTIMETRO DIGITAL
0-100V**

Cod. VM-100V



**BUZZER ALARMA
CHICHARRA 3V A
24V DC ZUMBADOR
GRANDE ARDUINO**

Cod. JV-SFM-27



**SENSOR DE PULSO
RITMO CARDIACO**

Cod. ARD-SPULSO



RAINDROPS SENSOR DE HUMEDAD, SENSIBLE A LA LLUVIA 3.3-5V

Cod. ARD-SRD



SENSOR INFRAROJO DE OBSTÁCULOS

Cod. ARD-KY032



MODULO REGULADOR DE VELOCIDAD DE MOTOR -SCR .

Cod. ARD-MRVEL

-5%



MÓDULO CONTROLADOR MOTOR L298N -DOBLE PUENTE H

Cod. ARD-ML298N

-10%

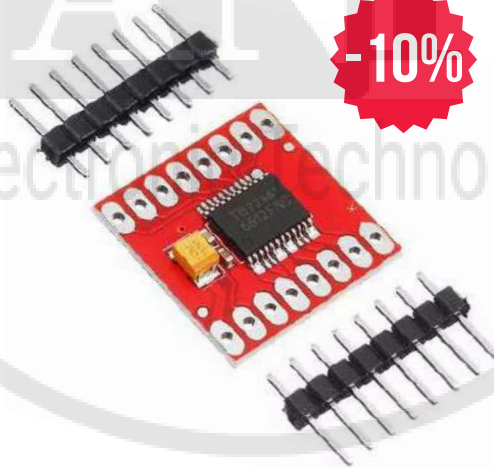

CONTROLADOR MOTOR ARDUINO TB6612FNG

Cod. ARD-CTB6612



MODULO CONVERTIDOR DC DC 24VDC/12VDC 5V XY-3606 ARDUINO

Cod. ARD-XY3606

-25%



**SENSOR OBSTACULOS
INFRARROJO**

Cod. ARD-S0

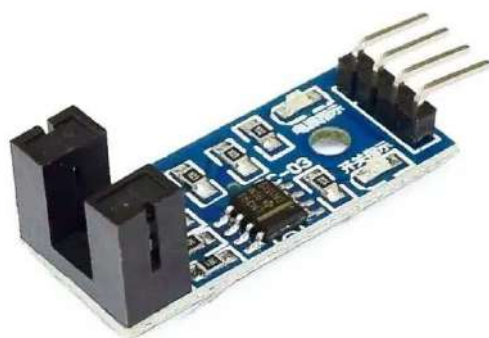

**SENSOR DE VELOCIDAD
TIPO HERRADURA
(LM393 - ENCODE)**

Cod. ARD-MVLM393

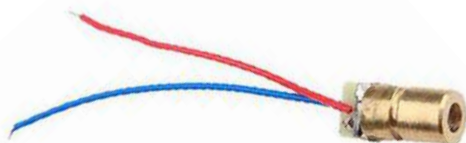

DIODO LASER

Cod. 44088

YANIPPO®

Electronics Technology

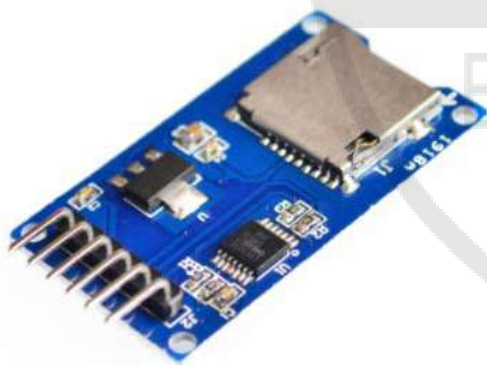

**MÓDULO LECTOR DE
TARJETA MICRO SD**

Cod. ARD-MICROSD

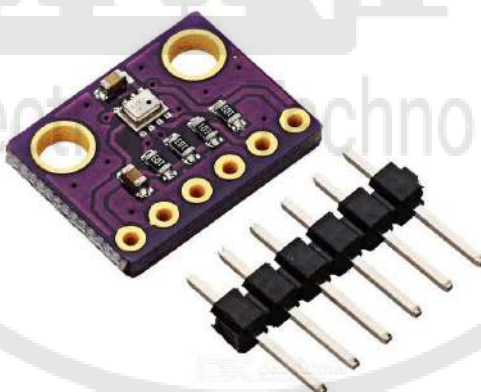

**SENSOR DE PRESIÓN
TEMPERATURA Y
ALTÍMETRO BMP280
ARDUINO**

Cod. ARD-BMP280

-10%



**SENSOR DE VIBRACIÓN
SW-420**

Cod. ARD-SVB

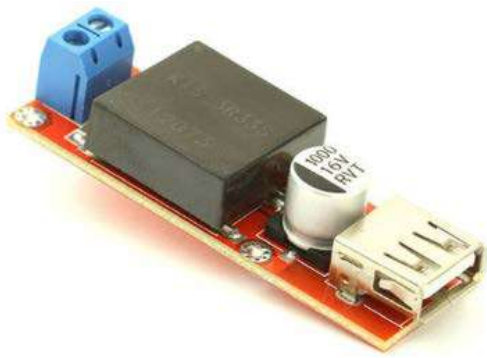

**MÓDULO REGULADOR DE
VOLTAJE**

Cod. MR-KIS3R33S

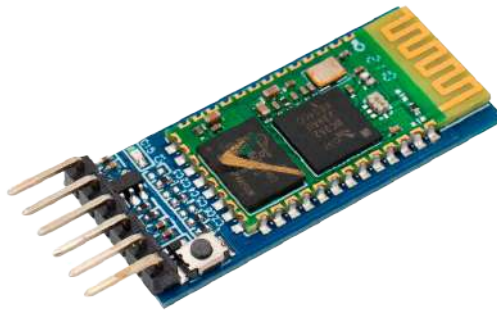

**MÓDULO BLUETOOTH
6 PINES**

Cod. HC-05



**AMPLIFICADOR DE AUDIO
DY-AP3001 30 WATTS**

Cod. JV-AP3016D



**MÓDULO SENSOR
HUNTING KY-033**

Cod. ARD-SKY033



**MÓDULO DE SENSOR
DE VIBRACIÓN
PIEZOELÉCTRICO**

Cod. ARD-SPZE



**BUZZER 5V MINI
REDONDO**

Cod. BUZZER

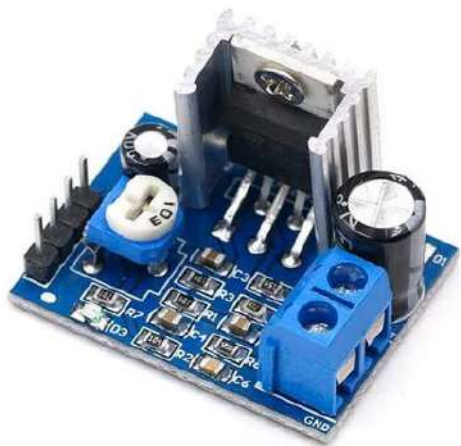

**MÓDULO AMPLIFICADOR
AUDIO TDA2030A**

Cod. ARD-TDA2030A



**MÓDULO LCD 2X16 CON
TECLADO**

Cod. ARD-LCDTEC



**MODULO MP3
BLUETOOTH 4.1**

Cod. ARD-MP3BT41



**MÓDULO FM RADIO
STEREO RDA5807M**

Cod. ARD-MFM



**MÓDULO CONTROLADOR
PASO A PASO DOBLE**

Cod. ARD-L9110S

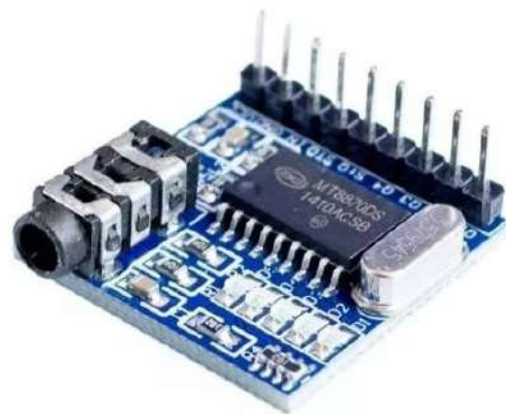

**DECODIFICADOR
DE VOZ DTFM
MT8870**

Cod. ARD-MT8870



**MODULO TRANCEPTOR
NRF2410 CON ANTENA**

Cod. ARD-MNRF2410A



**MÓDULO AMPLIFICADOR
DIGITAL PAM 8403**

Cod. ARD-MAMP



**MÓDULO BRÚJULA
DIGITAL HC5883L**

Cod. ARD-BJ



**MODULO
AMPLIFICADOR AUDIO
BLUETOOTH PAM8403
2X3W**

Cod. ARD-BTPAM8403

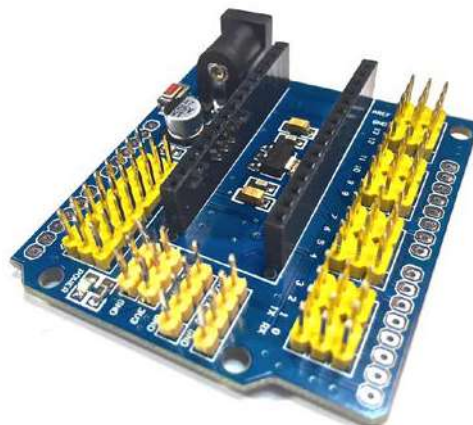

**MÓDULO EXPANSIÓN
ARDUINO NANO**

Cod. ARD-NANOEXT

-9%



**MÓDULO ACELERÓMETRO
CON GIROSCOPIO**

Cod. MPU-6050



MÓDULO WIFI ARDUINO

Cod. ESP8266



**SENSOR INFRARROJOS
TCRT5000**

Cod. ARD-STCRT5000



**MÓDULO FUENTE DE
PODER 5V-3.3V**

Cod. ARD-MB-102



**SENSOR DE VOLTAJE
0-25V RANGO DE
VOLTAJE: 0-25VCD
TAMAÑO: 25MM x
3MM/0.98 "x 0.51"**

Cod. ARD-SV



**MÓDULO ENCODER
GIRATORIO**

Cod. ARD-ECD

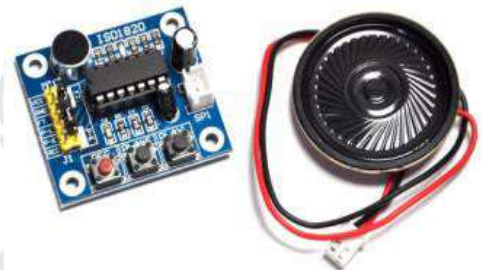

**MÓDULO DE
GRABACIÓN DE VOZ
ISD1820**

Cod. ARD-MGV

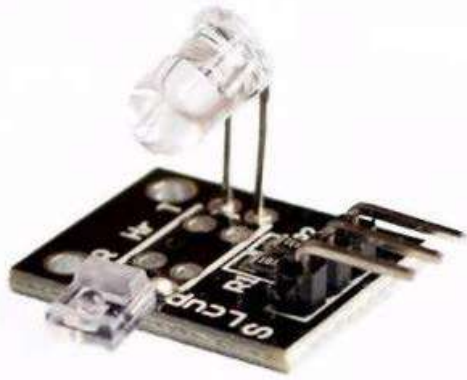

**SENSOR DE
LATIDOS TACTIL DEDO 5V**

Cod. SENSOR-CARDIO

-17%



**MÓDULO RELOJ EN
TIEMPO REAL DS1302**

Cod. ARD-DS1302



**SENSOR DE PROXIMIDAD
80CM**

Cod. ARD-SPX

YANIPPO®

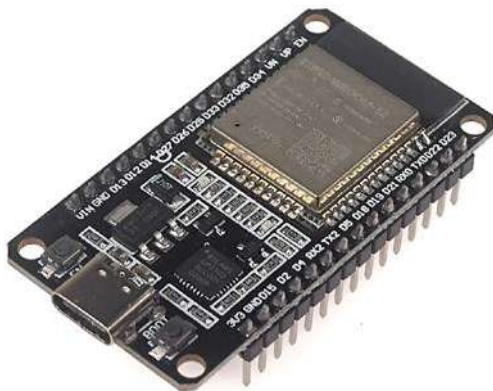

**PLACA DE DESARROLLO
IOT ESP32 DEVKITC -
30 PINES**

Cod. ARD-ESP32



**VOLTÍMETRO PARA TABLEROS,
FUENTES, AUTOS**

VOLTAJE DE ALIMENTACIÓN: 4.5-30 VDC
CORRIENTE DE OPERACIÓN < 15 MA
-VOLTAJE DE MEDICIÓN: 0-100 V DC, CON
POTENCIÓMETRO PARA AJUSTAR LA
EXACTITUD.

-LED COLOR ROJO

DIMENSIONES: 48X28X17MM

Cod. ARD-VOLDICU

-20%



**VOLTIMETRO DIGITAL
4.5V-30V**

Cod. VM-30V

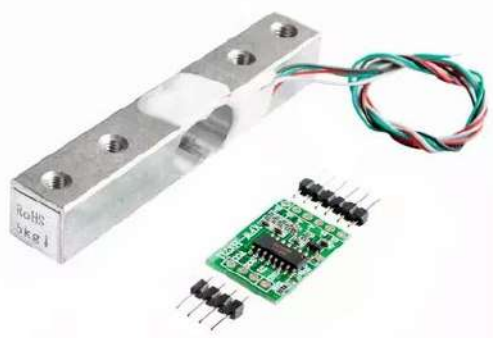

**CELDA DE CARGA 5KG +
CONVERSO HX711 SENSOR
PESO ARDUINO**

Cod. ARD-HX711-5KG



**MODULO WIFI LUA V3
ESP8266 ESP-12E**

Cod. ARD-MESP-12E



**SENSOR DE CORRIENTE
ACS712 CONVIERTE TU
TV EN SMARTV.**

Cod. ARD-SC

-10%

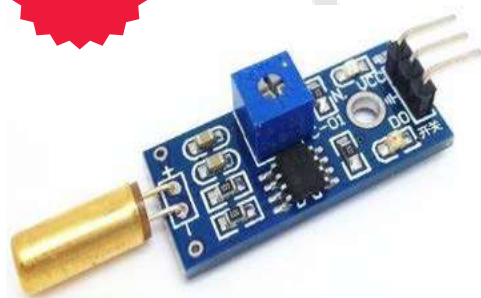

**MÓDULO SENSOR DE
INCLINACIÓN**

Cod. ARD-SINC

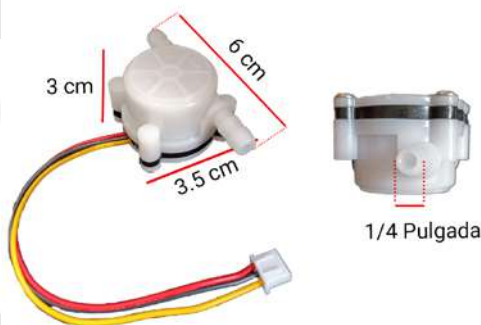

Working Range: 0.3 - 6L/min
Water Pressure: ≤ 0.8 MPa

**SENSOR CAUDAL DE
AGUA
-(.3-6L/MIN)**

Cod. ARD-SCAUDAL



**SENSOR HUMEDAD
RELATIVA HS1101**

Cod. ARD-HS1101

✓ Llegó



**MODULO LED SEMAFORO
LUCES CONTROL TRAFICO
5V ARDUINO PIC**

Cod. ARD-SMFO

✓ Llegó

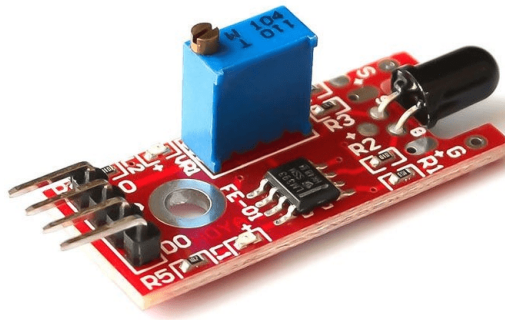

**MODULO SENSOR
DETECTOR DE FLAMA
KY-026**

Cod. ARD-KY026

✓ Llegó

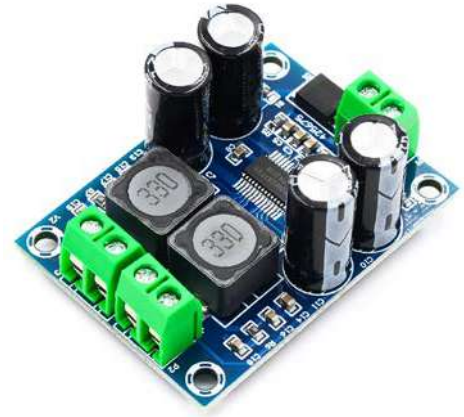

**MODULO AMPLIFICADOR
DE AUDIO XH-M31**

Cod. ARD-M311

-10%

✓ Llegó



**SENSOR DETECTOR DE
LLAMA**

Cod. ARD-SLLAMA

✓ Llegó



**MODULO AMPLIFICADOR
PAM8403**

Cod. ARD-PT8403

✓ Llegó



**MÓDULO CONVERTOR
USB A T**

Cod. PL2303HX

-7%

✓ Llegó

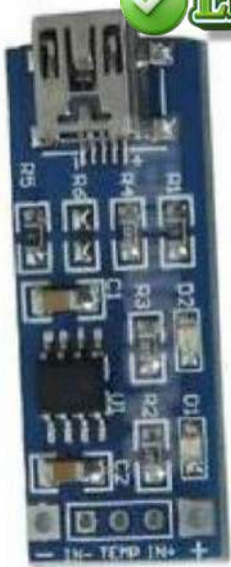

MÓDULO CARGADOR BATERIA LITIO ARDUINO

Cod. ARD-MCB

-7%

✓ Llegó



SENSOR INFRAROJO DE MOVIMIENTO

Cod. HC-SR501

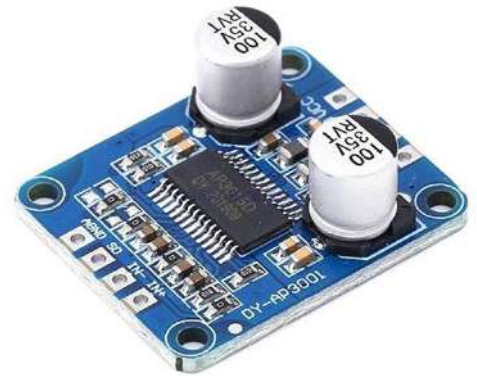

AMPLIFICADOR DE AUDIO DY-AP3001 30 WATTS

Cod. JV-AP3016D

✓ Llegó

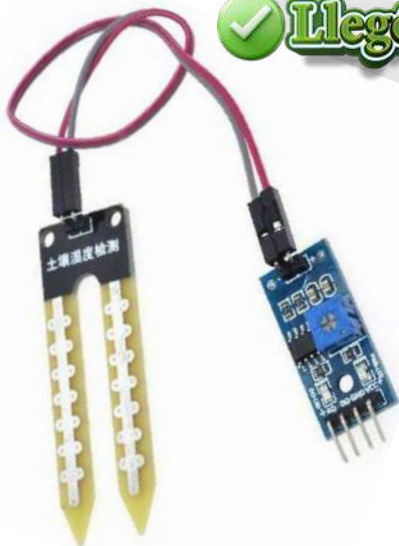

SENSOR HUMEDAD

Cod. ARD-SH

✓ Llegó



MODULO FUENTE REGULADOR XL4016 STEP DOWN

Cod. ARD-MXL4016

✓ Llegó

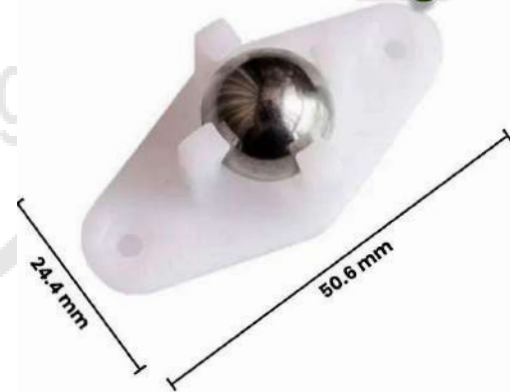

RUEDA LIBRE LOCA DE ACERO W420 ARDUINO

Cod. ARD-RW420

✓ Llegó

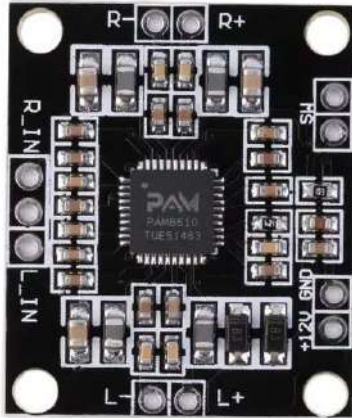

**AMPLIFICADOR PAM8610
2X15W ARDUINO**

Cod. ARD-PAM8610

-6%

✓ Llegó



MODULO HUMIFICADOR

Cod. ARD-MHFR

-13%

✓ Llegó

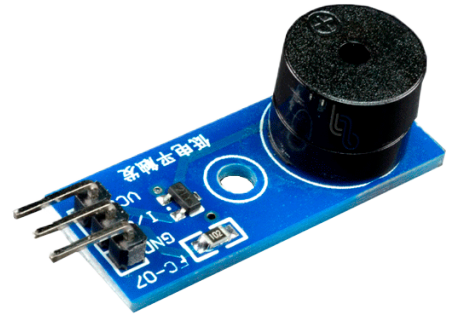

MÓDULO BUZZER

Cod. ARD-BZZ

-7%

✓ Llegó

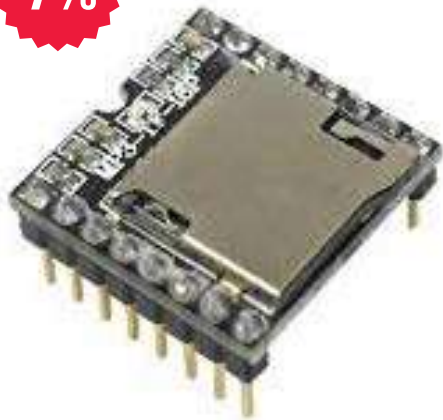

REPRODUCTOR MP3 MINI

Cod. ARD-MP3M

✓ Llegó

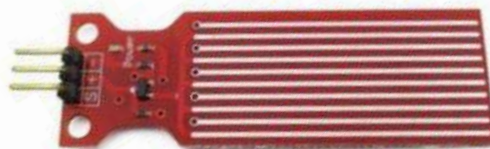

**SENSOR NIVEL DE AGUA
PROFUNDIDAD YKS**

Cod. ARD-SAGUA

-14%

✓ Llegó



**SENSOR TEMPERATURA
HUMEDAD RELATIVA
DHT11**

Cod. ARD-DTH11

✓ Llegó



MODULO GPS CONTROL DE VUELO NEO 6M 0 001 GY GPS6MV2

Cod. ARD-GPS6MV2

✓ Llegó



MODULO SENSOR TEMPERATURA

Cod. ARD-MSTDG

-11%

✓ Llegó



MÓDULO MOTOR DE PASO MULN2003APG

Cod. ARD-MULN2003APG

✓ Llegó

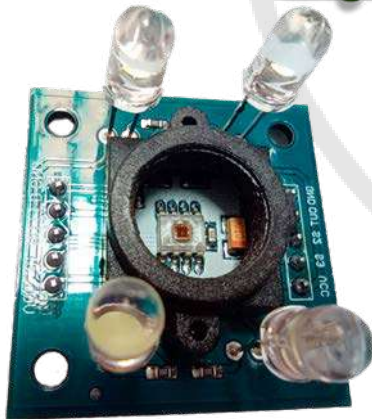

SENSOR DE COLOR

Cod. ARD-SCL

✓ Llegó

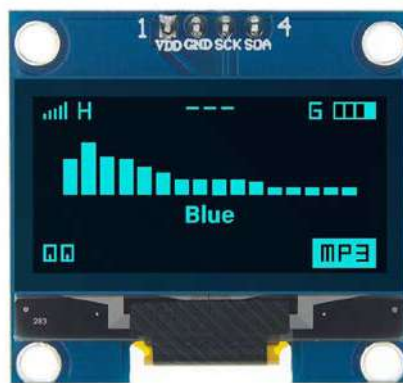

PANTALLA DISPLAY LDC OLED 0.96 PULGADAS 128X64 I2C AZUL

Cod. ARD-PDOLED

✓ Llegó



MODULO AMPLIFICADOR DE AUDIO PAM8610 VARIABLE

Cod. ARD-MAA8610

✓ Llegó



MODULO HUMEDAD SUELO CAPACITIVO

Cod. ARD-MHSC

✓ Llegó



MATRIZ LED 8X8X4 DIGITOS MAX7219 ARDUINO

Cod. ARD-MZ8X8X4

✓ Llegó

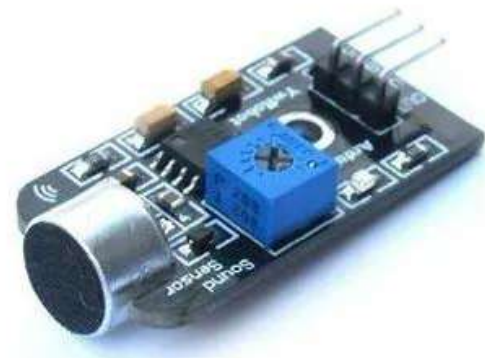

SENSOR DE SONIDO

Cod. ARD-SS

✓ Llegó



MODULO AMPLIFICADOR AUDIO TPA3110

Cod. ARD-TPA3110

✓ Llegó



TP4056 MODULO USB CARGADOR BATERÍA LITIO 18650 ARDUINO

Cod. ARD-TP4056C

✓ Llegó



MODULO TRANSMISOR RECEPTOR WIFI ESP-01S ARDUINO

Cod. ESP-01S

✓ Llegó



MODULO L298 MINI SMD

Cod. ARD-MINIL298

-12%

✓ Llegó

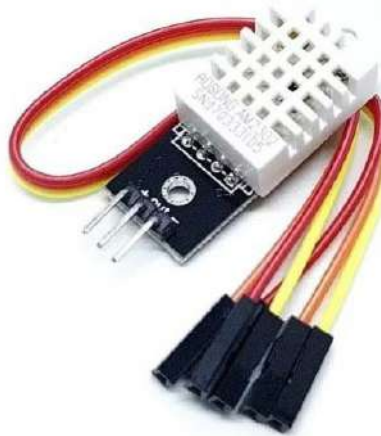

SENSOR HUMEDAD
TEMPERATURA DHT22

Cod. ARD-SDHT22

✓ Llegó



MÓDULO JOYSTICK

Cod. KY-023



MINI ALTAVOZ REDONDO 8
OHM 1W 20MM

Cod. ARD-P8-1W

✓ Llegó



SENSOR REFLECTIVO
CNY70, SEGUIDOR DE
LINEA

Cod. CNY70

✓ Llegó



MODULO CONTROL RF
NEGRO 4 CANALES

Cod. ARD-NE433-4CA

✓ Llegó



**MODULO CONTROL
REMOTO EMISOR 4
CANALES 433MHZ**

Cod. ARD-TA433-4CA

✓ Llegó



**MODULO RECEPTOR
RF 433MHZ 1 CANAL
UNIVERSAL 12V ARDUINO**

Cod. ARD-M433-1CA

✓ Llegó



**MODULO DIMMER
12V-24V**

Cod. ARD-DIMMER

✓ Llegó

-7%

✓ Llegó



**MODULO TEMPORIZADOR
TIMER 555**

Cod. ARD-MTT555



**SENSOR SONDA
TEMPERATURA
DS18B20**

Cod. ARD-SDS18B20

✓ Llegó



**MÓDULO REGULADOR
DE MOTOR PWM DC
12V/24V/30V/40V CON
INTERRUPTOR DE CONTROL
DE VELOCIDAD 10A .**

Cod. ARD-MRPWM

-7%

✓ **Llegó**



**ELECTROVÁLVULA
SOLENOIDE 12V 1/2 -
CONTROL AGUA**

Cod. ARD-SPS12V

✓ **Llegó**

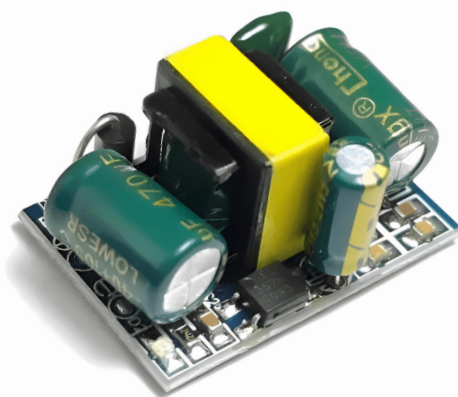

**MÓDULO FUENTE DE
ALIMENTACIÓN AISLADA
AC-DC 12V 450MA 5.4W**

Cod. ARD-MFC12V

YANIPPO[®]
Electronic Technology

YANPO[®]
ELECTRONIC TECHNOLOGY

LED'S E INTEGRADOS

**LEDS 1W BLANCO
SIN DISIPADOR**



Cod. 1W-WHITE

**LEDS 3W BLANCO
SIN DISIPADOR**



Cod. LED3W-W-S-D

LEDS 1W CON *DISIPADOR*



Red



**LED 1W ROJO
CON DISIPADOR**

Cod. LED1W-RED-DIS

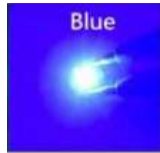

Blue



**LED 1W AZUL
CON DISIPADOR**

Cod. LED1W-BLUE-DIS



Green



**LED 1W VERDE
CON DISIPADOR**

Cod. LED1W-GREEN-DIS

LEDS 3W CON *DISIPADOR*



Warm White



LED 3W CON DISIPADOR

Cod. LED3WDIS



Red



**LED 3W ROJO
CON DISIPADOR**

Cod. LED3W-RED-DIS



Blue



**LED 3W AZUL CON
DISIPADOR**

Cod. LED3W-BLUE-DIS



LED 10W BLANCO 12V 900MA

Cod. LED10W-W



LED DE POTENCIA 20 WATTS COLOR
BLANCO 32-34V

Cod. LED20W-W

YANIPPO[®]

Electronics Technology



LED DE POTENCIA 30
WATTS COLOR BLANCO
32-34V

Cod. LED30W-W



LED 50W BLANCO 32-34V
4000-4500LM

Cod. LED50W-W



LED 100W BLANCO
32-34V 8000-9000 LM

Cod. LED100W-W

Integrados, memorias, transistores, TTL's, TIPS, etc.

Transistores

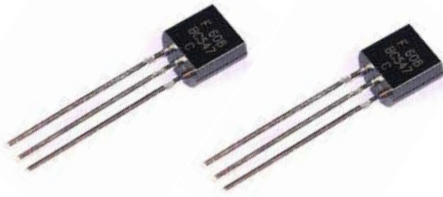

2SC4917	\$800
2SC5271	\$1.600
2SD1878	\$2.000
2SD1887	\$1.900

Transistores de potencia

2SA1962	\$5.500
2SC4460	\$ 1.900
2SC4834P	\$2.900
2SC4834M	\$2.900
2SC4917	\$800

TTL

74LS90	\$1.700
74LS174	\$1.200
74LS240P	\$1.400

Triac

FQPF7N60J	\$1.500
-----------	---------

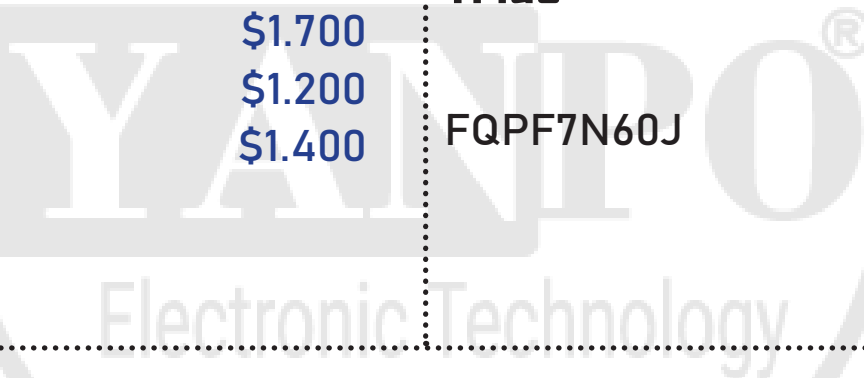

LM567	\$600
MJ15022	\$11.900
STRF6654	\$5.300
STRS5707	\$9.000
STRS6707	\$4.900
STRW6750	\$7.000
STRW6754	\$5.200
TA8403K	\$2.400
TB1238BN	\$7.500
TDA16846P	\$2.000
TDA8145	\$2.300
TT2170	\$1.450
1N4001	\$90

1N5400	\$90
J6810D	\$1.800
KA7630	\$2.300
KA7632	\$2.100
L6565	\$1.850
LA42102	\$3.300
LA78045	\$1.500
LA7674	\$5.600
2SA1962	\$5.500
4N25	\$600
44035	\$190



YANPO.COM.CO

**CENTRO LOGÍSTICO EJE CAFETERO
CARRERA 2 N #1-536 BODEGA 17
DOSQUEBRADAS - RISARALDA**